

Technical catalogue 2021



Variable area flowmeters
Standard and Compact series



Flow Indicators



VARIABLE AREA FLOWMETERS STANDARD AND COMPACT SERIES

The Technical Price List EF.06 is dedicated to all the products that FIP has designed, manufactured and selected for the measurement and the control of the fluids.

It allows an easy consultation, an accurate selection of the items and a quick identification of products to make you place orders easily.

The Area Variable Flowmeters Price List includes the complete line of rotameters specific for fluids and gases flowrate measurement. The range is available in 3 materials: PVC-U, Trogamid and Polysulfone, both in standard version (FS) and in compact version (FC).

In order to meet specific needs of plants and guarantee a greater flexibility of applications the selection has been completed with Adapters, Accessories and Spare Parts.





FIP branded products distributed by Aliaxis Italia are manufactured on production sites operating according to the Quality Assurance System in compliance with ISO 9001 and with the Environmental Management System ISO 14001 standards requirements.

Aliaxis Italia offer since ever a Technical Support service for the accurate selection, installation and use of products, as well as an accurate claim service according to ISO 10002.

Contacts

Reception	+39 010 9621.1
Information	info.fip@aliaxis.com
Technical support	technical.fip@aliaxis.com

Company Certificates

	Cert. N° 1 in compliance with the Standard UNI EN ISO 9001	
	Cert. N° 70 in compliance with the Standard UNI EN ISO 14001	

CE Conformity

	CE conformity according to European directives PED 2014/68/UE.
---	--

R00-03-2021

Contents

FS-FC DN 10÷65	
General Information	page 4
Technical Data	page 6
Components	page 8
Installations	page 9

Variable Area Flowmeters standard series and compact series

STANDARD SERIES FLOWMETERS

ISO METRIC SOCKET UNIONS	
H ₂ O Scale	page 12
NaOH 30% Scale	page 14
NaOH 50% Scale	page 16
HCl 30-33% Scale	page 18
Air Scale	page 19
BSP SOCKET THREADED UNIONS	
H ₂ O Scale	page 20
NaOH 30% Scale	page 22
NaOH 50% Scale	page 24
HCl 30-33% Scale	page 26
Air Scale	page 27

COMPACT SERIES FLOWMETERS

ISO METRIC SOCKET UNIONS	
H ₂ O Scale	page 28
NaOH 30% Scale	page 30
NaOH 50% Scale	page 32
HCl 30-33% Scale	page 34
Air Scale	page 35
BSP SOCKET THREADED UNIONS	
H ₂ O Scale	page 36
NaOH 30% Scale	page 38
NaOH 50% Scale	page 40
HCl 30-33% Scale	page 42
Air Scale	page 43

Accessories for Variable Area Flowmeters

Accessories for FS - FC series	page 46
--------------------------------	---------

Spare Parts for Variable Area Flowmeters

Spare Parts for FS - FC series	page 58
--------------------------------	---------

Key abbreviations	page 61
Conditions of Supply	page 62

FS-FC DN 10 ÷ 65



Plastic Variable Area Flowmeters in
PVC-U , PA and PSU



FS-FC DN 10÷65

These flowmeters operate according to the variable area principle, where a float is suspended in upward flowing media in a tapered plastic tube. The vertical position of the float within the metering tube depends on the flowrate of the media.

The metering tube is graduated in suitable flow units and the reading is taken in correspondence with the top edge of the float. Versions for liquids and gases are available, providing accurate and cost effective measurement with scales in l/h and Nm³/h.

PLASTIC VARIABLE AREA FLOWMETERS

- **Wide choice of measuring scales:** water scale from 1,5 to 50.000 l/h, HCl scale from 1,4 to 23.000 l/h, NaOH 30% scale from 0,25 to 43.000 l/h, NaOH 50% scale from 0,025 to 40.000 l/h, Air scale from 0,025 to 500 Nm³/h
- **Wide choice of end connections** available in PVC-U, PVC-C, PP-H, AISI 316 SS, Carbon Steel
- Eight different diameters
- Three different plastic tube materials: PA, PVC and PSU
- Float materials available in SS and PP, with or without magnet
- **High level of accuracy:** FS accuracy class 2,5; FC accuracy class 4
- Simple operation and very limited maintenance.
- Other engineering units like LPM, m³/h or % together with **double scales and special scales** are available on request.

Technical specifications	
Construction	FS: Standard variable area flowmeters FC: Compact variable area flowmeters
Size range	DN 10 ÷ 65
Operating pressure	PVC-U, PVC-C, PP end connectors: 10 bar with water at 20 °C Carbon Steel, Stainless Steel end connectors: 15 bar with water at 20 °C
Temperature range	PVC-U (supplied as standard) Transparent PVC-U, Trogamid, Polysulfone (PSU): from 5 °C (41 °F) to 60 °C (140 °F) PVC-C Transparent PVC-U, Trogamid: from 5 °C (41 °F) to 60 °C (140 °F) Polysulfone (PSU): from 5 °C (41 °F) to 80 °C (176 °F) PP-H Transparent PVC-U, Trogamid: from 5 °C (41 °F) to 60 °C (140 °F) Polysulfone (PSU): from 0 °C (32 °F) to 90 °C (194 °F) AISI 316 Stainless Steel, Carbon Steel Transparent PVC-U: from 5 °C (41 °F) to 60 °C (140 °F) Trogamid: from -20 °C (-4 °F) to 60 °C (140 °F) Polysulfone (PSU): from -20 °C (-4 °F) to 100 °C (212 °F)
Coupling standards	PVC-U (supplied as standard) Solvent welding metric size according to: ISO 727, EN ISO 1452, EN ISO 15493, Parallel threads according to: ISO 228-1, EN 10226- 1/2 PVC-C Solvent welding metric size according to: EN ISO 15493 PP-H Socket fusion according to: EN ISO 15494 AISI 316 Stainless Steel Parallel threads according to: ISO 228-1, EN 10226- 1/2 Carbon Steel Parallel threads according to: ISO 228-1, EN 10226- 1/2
Tube material	PVC-U, PA, PSU
Seal material	EPDM supplied as standard, FKM
Float material	Red PP, AISI 316 Stainless Steel

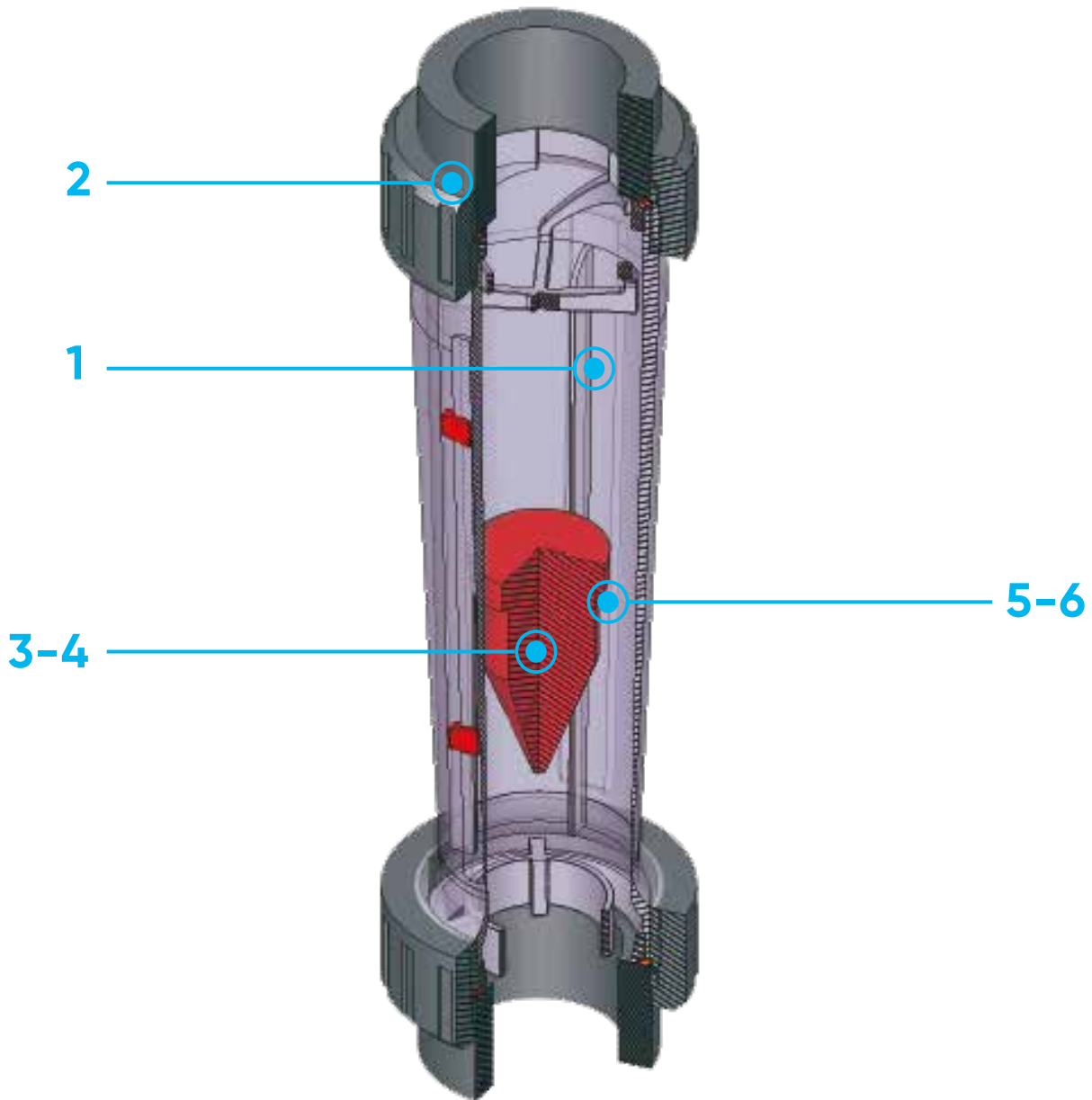

- 1** Metering **tubes** are available in Trogamid (PA) suitable for **most inert media**, PVC-U suitable for **slight corrosive media** and Polysulfone (PSU) suitable for **corrosive media** on an extended operating temperature range.
- 2** **End connectors** available in PVC-U, PVC-C, PP, SS, Malleable Cast Iron. Male threads moulded onto the end of the metering tube are used for **easy mounting of unions**. Standard unions are in PVC-U but others are available **according to the different working conditions**; Metal unions

- 3** **widen the range of operating conditions** such as pressure and temperature.
- 4** The **floats** are available in Stainless Steel AISI 316 and in PP to match the **proper chemical compatibility** with the flow medium and to offer different measuring ranges.
- 5** **Magnetic Float option** is available to be combined with micro switches for **MIN and MAX alarm**, clamped on the guide of the flowmeter. The micro switches, housing a bi-stable reed contact are activated

- by the passage of the magnet incorporated into the float.
- 6** Flowmeters body are equipped with a **double guide** allowing the installation of **two alarm in a very close position**.
- 7** **Double scale option** available for specific application requirements to **customize measuring units** for an easy conversion or comprehension of the flow rate values.

TECHNICAL DATA

PRESSURE VARIATION ACCORDING TO TEMPERATURE

For water and harmless fluids to which the material is classified as CHEMICALLY RESISTANT. In other cases, a reduction of the nominal PN pressure is required (25 years with safety factor).

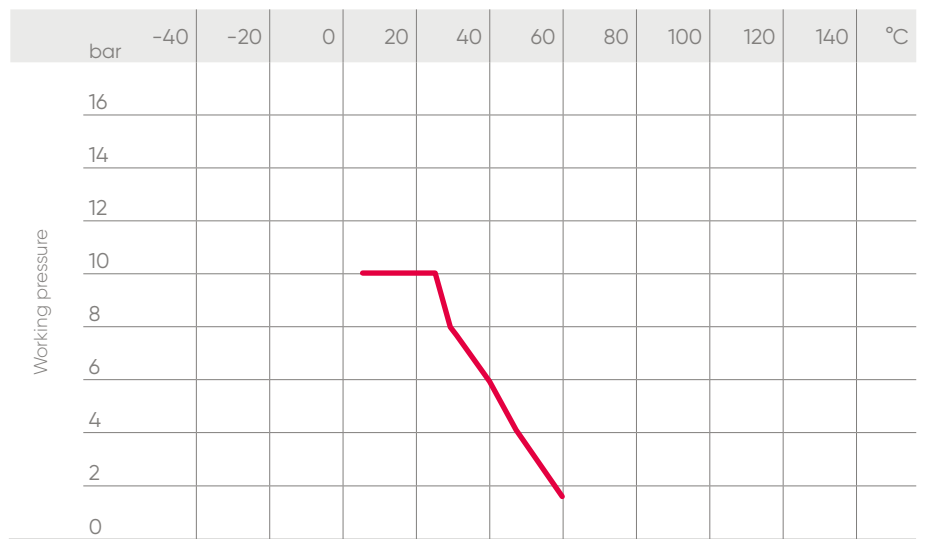

Transparent PVC-U ■ PVC-U - PVC-C - PP - SS - CAST IRON Working temperature

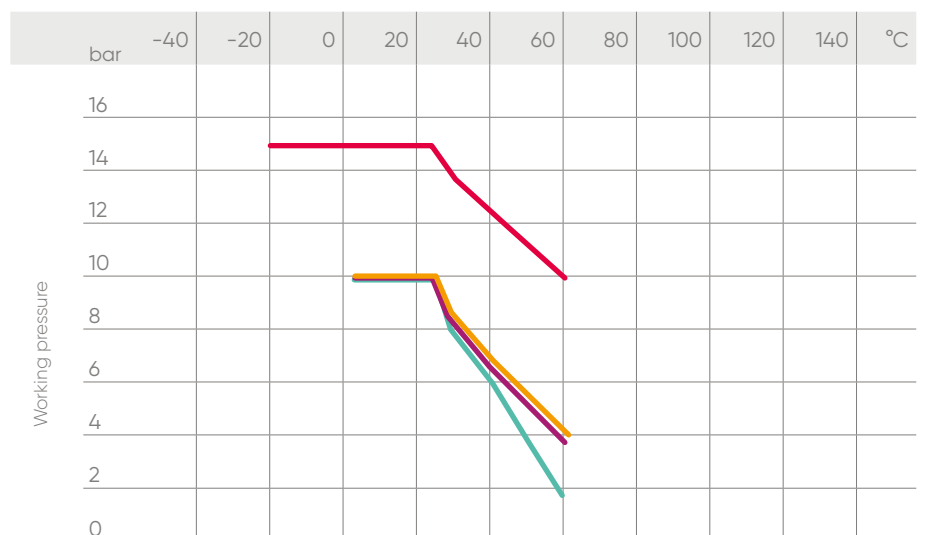

Trogamid ■ SS-CAST IRON ■ PVC-C ■ PP ■ PVC-U Working temperature

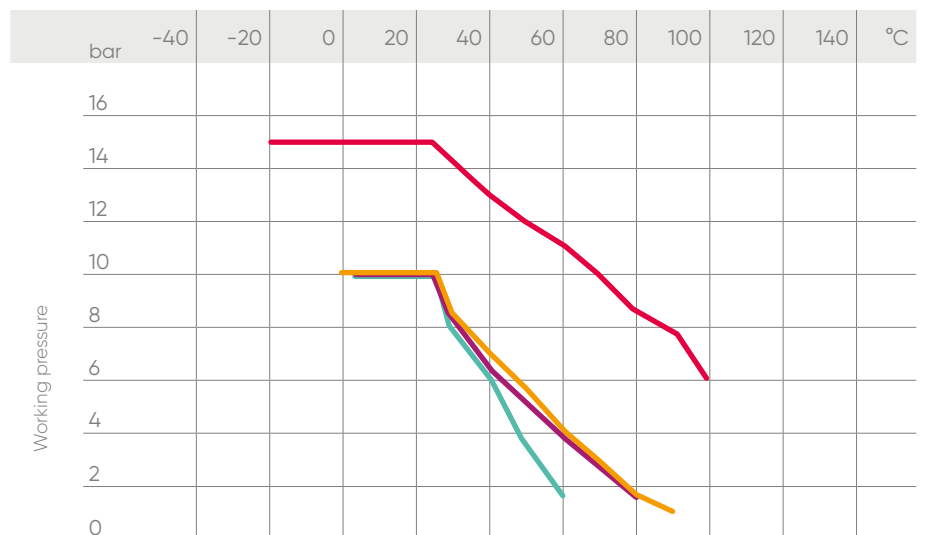

Polysulfone ■ SS-CAST IRON ■ PVC-C ■ PP ■ PVC-U Working temperature

FS SERIES PRESSURE DROP GRAPH

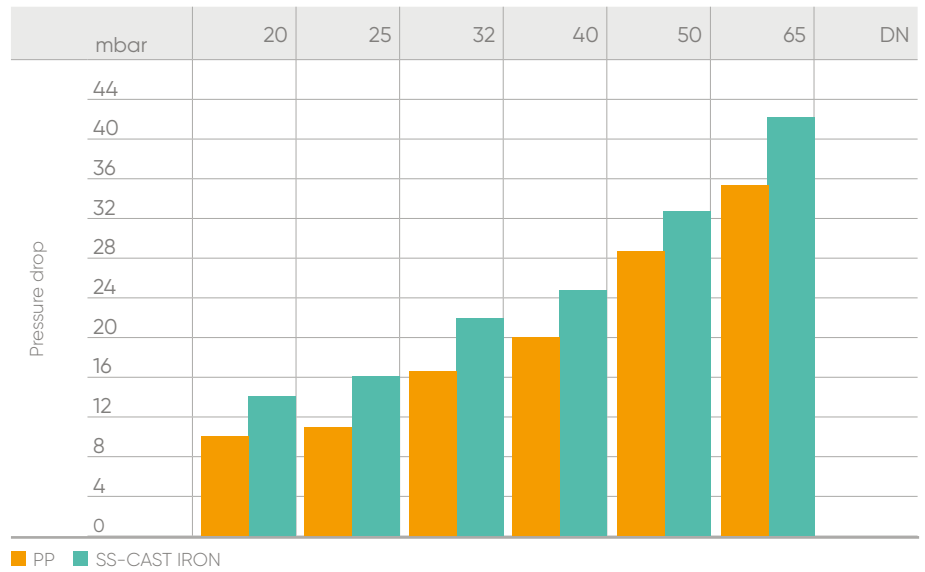

FC SERIES PRESSURE DROP GRAPH

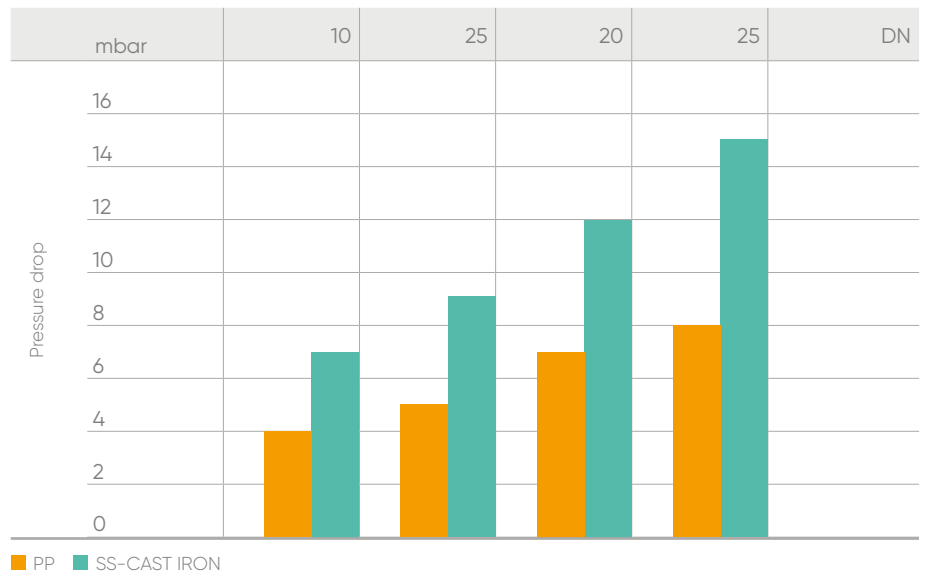

The information in this leaflet is provided in good faith. No liability will be accepted concerning technical data that is not directly covered by recognised international standards. FIP reserves the right to carry out any modification. Products must be installed and maintained by qualified personnel.

COMPONENTS

EXPLODED VIEW

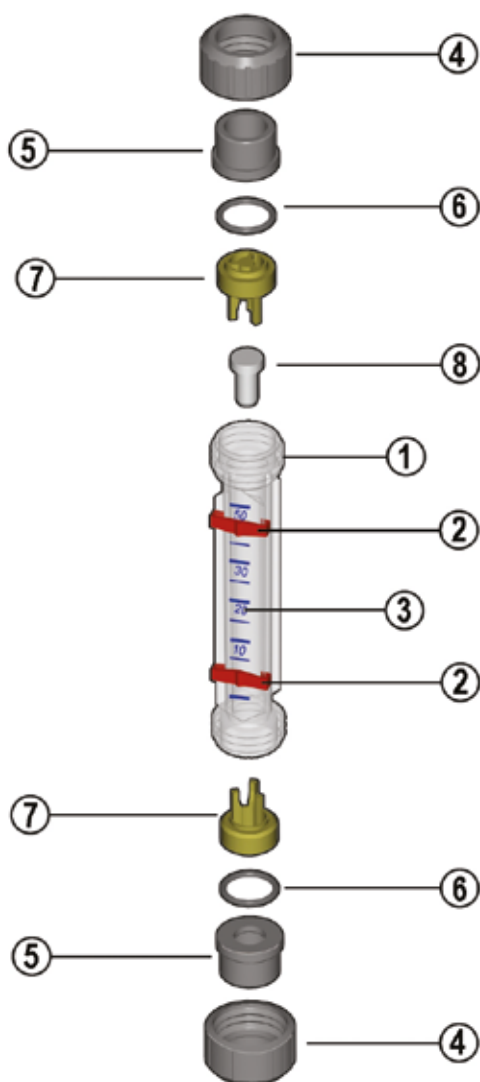

- 1 Tube (Transparent PVC-U-
Trogamid PA-Polisulfone PSU - 1)
- 2 Visual flow indicator (POM - 2)*
- 3 Scale (LABEL/TAMPOPRINT - 1)

- 4 Nut (PVC-U - 2)*
Nut (PVC-C-PP-SS-Carbon Steel
- 2)**
- 5 End Connector (PVC-U - 2)*
End Connector (PVC-C-PP-SS-

- Carbon Steel - 2)**
- 6 O-Ring (EPDM*-FKM** - 2)
- 7 Float stop (PVDF - 2)*
- 8 Float (SS - SS+magnet - Red PP
- Red PP+magnet - 1)*

* Spare parts

** Accessories

The component material and quantity supplied are indicated in the parentheses.

INSTALLATION

For specific device sizes the float is inserted with a plastic net for transport lock. This must be removed through the top of the meter before installation. After that the free movement of the float inside the flow tube should be checked again.

The device must be mounted vertically and stress-free. Reductions, extensions, and control elements upstream and downstream of the meter have no influence on the measurement accuracy with liquids. For gases, however, the installation of the meter is recommended before valves to prevent compression oscillations.

Since variable flow meters are very sensitive to changes in flow, control elements should always be adjusted slowly.

The calibration is carried out for defined terms. Deviations of the density, pressure or temperature of gases, as well as density and viscosity of liquids, result in errors. It is essential to ensure compliance with the calibration conditions.

In case of medium different from the standard reference scales provided, it is essential to consider the data of the specific medium such as density and viscosity. In case of gases different from air, the exact reference point for the pressure (gauge or absolute) has to be specified. Retrofitting of switching contacts is only possible when the floats are equipped with magnets.

- 1) The medium must flow through the flowmeter from bottom to top. Flowmeter must be mounted vertical
- 2) Inlet / outlet distances:
 - If inlet and outlet pipe DN dimensions are the same as the flowmeter DN, no inlet/outlet distances are required
 - If a bend or elbow is on the inlet and / or outlet it is recommended to increase the inlet distance to 10 times the nominal size of the flowmeter (10xDN).
 - If there are sensible differences in nominal sizes, it is recommended to increase the inlet distance to 10 times the nominal size of the flowmeter (10xDN).
 - For use with gases, it is recommended to increase the inlet distance to 5 times the nominal size of the flowmeter (5xDN).
- 3) With liquid media, isolating or control valves may be mounted both upstream or downstream the flowmeter
- 4) With gaseous media, control valves are recommended to be mounted downstream the flowmeter
- 5) All control valves must be open slowly and gradually due to the high sensitivity of the float to flow variations
- 6) Unscrew the union nuts 4.
- 7) Push the union nuts 4 onto the pipes.
- 8) Solvent cement, weld or screw the inserts 5 onto the pipes.
- 9) Insert the O-rings 6 into the metering tube.
- 10) Place the metering tube 1 between the pipes and screw it in tight with the union nuts 4.

WARNINGS

Float may fall out!
Float may get damaged
Carefully unscrew the union nuts
Metering tube and float must be clean and free from harmful substances
Dust protection caps and transportation protection must be removed
Pipelines must be aligned and installed without any mechanical stress
The flow is from bottom to top
Pipeline vibrations can damage the flowmeter
The media pressure has to overcome the pressure loss at the float

FS-FC



Product range of Variable Area Flowmeters



FS – STANDARD VERSION FLOWMETERS

H2O SCALE – SS FLOAT

LIQUID DENSITY: 1KG/L 20 °C – ISO METRIC SOCKET UNIONS

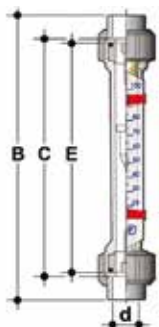

FSIV

Float: AISI 316 Stainless Steel

d	Flow rate range for H ₂ O [l/h]	B	E	C	Trogamid code	Transparent PVC-T code	Polysulfone code
25	25-250	394	350	356	FSIV025D1X0250	FSIV025T1X0250	FSIV025P1X0250
25	40-400	394	350	356	FSIV025D1X0400	FSIV025T1X0400	FSIV025P1X0400
25	60-640	394	350	356	FSIV025D1X0640	FSIV025T1X0640	FSIV025P1X0640
25	100-1000	394	350	356	FSIV025D1X1000	FSIV025T1X1000	FSIV025P1X1000
32	40-400	400	350	356	FSIV032D1X0400	FSIV032T1X0400	FSIV032P1X0400
32	60-640	400	350	356	FSIV032D1X0640	FSIV032T1X0640	FSIV032P1X0640
32	100-1000	400	350	356	FSIV032D1X1000	FSIV032T1X1000	FSIV032P1X1000
32	150-1600	400	350	356	FSIV032D1X1600	FSIV032T1X1600	FSIV032P1X1600
40	150-1600	408	350	356	FSIV040D1X1600	FSIV040T1X1600	FSIV040P1X1600
40	200-2500	408	350	356	FSIV040D1X2500	FSIV040T1X2500	FSIV040P1X2500
40	400-4000	408	350	356	FSIV040D1X4000	FSIV040T1X4000	FSIV040P1X4000
50	200-2500	418	350	356	FSIV050D1X2500	FSIV050T1X2500	FSIV050P1X2500
50	400-4000	418	350	356	FSIV050D1X4000	FSIV050T1X4000	FSIV050P1X4000
50	500-5000	418	350	356	FSIV050D1X5000	FSIV050T1X5000	FSIV050P1X5000
63	400-4000	432	350	356	FSIV063D1X4000	FSIV063T1X4000	FSIV063P1X4000
63	600-6000	432	350	356	FSIV063D1X6000	FSIV063T1X6000	FSIV063P1X6000
63	1000-10000	432	350	356	FSIV063D1X0010	FSIV063T1X0010	FSIV063P1X0010
75	1500-15000	444	350	356	FSIV075D1X0015	FSIV075T1X0015	FSIV075P1X0015
75	2000-20000	444	350	356	FSIV075D1X0020	FSIV075T1X0020	FSIV075P1X0020
75	10000-50000	444	350	356	FSIV075D1X0050	FSIV075T1X0050	FSIV075P1X0050

Float: AISI 316 Stainless Steel + Magnet

d	Flow rate range for H ₂ O [l/h]	B	E	C	Trogamid code	Transparent PVC-T code	Polysulfone code
25	25-250	394	350	356	FSIV025D1X0250M	FSIV025T1X0250M	FSIV025P1X0250M
25	40-400	394	350	356	FSIV025D1X0400M	FSIV025T1X0400M	FSIV025P1X0400M
25	60-640	394	350	356	FSIV025D1X0640M	FSIV025T1X0640M	FSIV025P1X0640M
25	100-1000	394	350	356	FSIV025D1X1000M	FSIV025T1X1000M	FSIV025P1X1000M
32	40-400	400	350	356	FSIV032D1X0400M	FSIV032T1X0400M	FSIV032P1X0400M
32	60-640	400	350	356	FSIV032D1X0640M	FSIV032T1X0640M	FSIV032P1X0640M
32	100-1000	400	350	356	FSIV032D1X1000M	FSIV032T1X1000M	FSIV032P1X1000M
32	150-1600	400	350	356	FSIV032D1X1600M	FSIV032T1X1600M	FSIV032P1X1600M
40	150-1600	408	350	356	FSIV040D1X1600M	FSIV040T1X1600M	FSIV040P1X1600M
40	200-2500	408	350	356	FSIV040D1X2500M	FSIV040T1X2500M	FSIV040P1X2500M
40	400-4000	408	350	356	FSIV040D1X4000M	FSIV040T1X4000M	FSIV040P1X4000M
50	200-2500	418	350	356	FSIV050D1X2500M	FSIV050T1X2500M	FSIV050P1X2500M
50	400-4000	418	350	356	FSIV050D1X4000M	FSIV050T1X4000M	FSIV050P1X4000M
50	500-5000	418	350	356	FSIV050D1X5000M	FSIV050T1X5000M	FSIV050P1X5000M
63	400-4000	432	350	356	FSIV063D1X4000M	FSIV063T1X4000M	FSIV063P1X4000M
63	600-6000	432	350	356	FSIV063D1X6000M	FSIV063T1X6000M	FSIV063P1X6000M
63	1000-10000	432	350	356	FSIV063D1X0010M	FSIV063T1X0010M	FSIV063P1X0010M
75	1500-15000	444	350	356	FSIV075D1X0015M	FSIV075T1X0015M	FSIV075P1X0015M
75	2000-20000	444	350	356	FSIV075D1X0020M	FSIV075T1X0020M	FSIV075P1X0020M
75	10000-50000	444	350	356	FSIV075D1X0050M	FSIV075T1X0050M	FSIV075P1X0050M

FS – STANDARD VERSION FLOWMETERS

H2O SCALE – PP FLOAT

LIQUID DENSITY: 1KG/L 20 °C – ISO METRIC SOCKET UNIONS

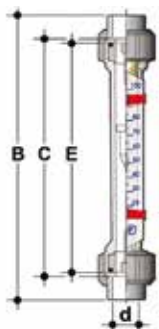

FSIV

Float: PP (Polypropylene) red

d	Flow rate range for H ₂ O [l/h]	B	C	E	Trogamid code	Transparent PVC-T code	Polysulfone code
25	15 - 150	394	356	350	FSIV025D1M0150	FSIV025T1M0150	FSIV025P1M0150
25	25 - 250	394	356	350	FSIV025D1M0250	FSIV025T1M0250	FSIV025P1M0250
25	45 - 450	394	356	350	FSIV025D1M0450	FSIV025T1M0450	FSIV025P1M0450
25	70 - 700	394	356	350	FSIV025D1M0700	FSIV025T1M0700	FSIV025P1M0700
32	25 - 250	400	356	350	FSIV032D1M0250	FSIV032T1M0250	FSIV032P1M0250
32	40 - 400	400	356	350	FSIV032D1M0400	FSIV032T1M0400	FSIV032P1M0400
32	65 - 650	400	356	350	FSIV032D1M0650	FSIV032T1M0650	FSIV032P1M0650
32	100 - 1000	400	356	350	FSIV032D1M1000	FSIV032T1M1000	FSIV032P1M1000
40	100 - 1000	408	356	350	FSIV040D1M1000	FSIV040T1M1000	FSIV040P1M1000
40	160 - 1600	408	356	350	FSIV040D1M1600	FSIV040T1M1600	FSIV040P1M1600
40	200 - 2500	408	356	350	FSIV040D1M2500	FSIV040T1M2500	FSIV040P1M2500
50	150 - 1600	418	356	350	FSIV050D1M1600	FSIV050T1M1600	FSIV050P1M1600
50	200 - 2200	418	356	350	FSIV050D1M2200	FSIV050T1M2200	FSIV050P1M2200
50	250 - 2500	418	356	350	FSIV050D1M2500	FSIV050T1M2500	FSIV050P1M2500
63	250 - 2500	432	356	350	FSIV063D1M2500	FSIV063T1M2500	FSIV063P1M2500
63	350 - 3500	432	356	350	FSIV063D1M3500	FSIV063T1M3500	FSIV063P1M3500
63	500 - 5000	432	356	350	FSIV063D1M5000	FSIV063T1M5000	FSIV063P1M5000
75	1000 - 8000	444	356	350	FSIV075D1M8000	FSIV075T1M8000	FSIV075P1M8000
75	1000 - 10000	444	356	350	FSIV075D1M0010	FSIV075T1M0010	FSIV075P1M0010
75	5000 - 25000	444	356	350	FSIV075D1M0025	FSIV075T1M0025	FSIV075P1M0025

Float: PP (Polypropylene) red + Magnet

d	Flow rate range for H ₂ O [l/h]	B	C	E	Trogamid code	Transparent PVC-T code	Polysulfone code
25	15 - 150	394	356	350	FSIV025D1M0150M	FSIV025T1M0150M	FSIV025P1M0150M
25	25 - 250	394	356	350	FSIV025D1M0250M	FSIV025T1M0250M	FSIV025P1M0250M
25	45 - 450	394	356	350	FSIV025D1M0450M	FSIV025T1M0450M	FSIV025P1M0450M
25	70 - 700	394	356	350	FSIV025D1M0700M	FSIV025T1M0700M	FSIV025P1M0700M
32	25 - 250	400	356	350	FSIV032D1M0250M	FSIV032T1M0250M	FSIV032P1M0250M
32	40 - 400	400	356	350	FSIV032D1M0400M	FSIV032T1M0400M	FSIV032P1M0400M
32	65 - 650	400	356	350	FSIV032D1M0650M	FSIV032T1M0650M	FSIV032P1M0650M
32	100 - 1000	400	356	350	FSIV032D1M1000M	FSIV032T1M1000M	FSIV032P1M1000M
40	100 - 1000	408	356	350	FSIV040D1M1000M	FSIV040T1M1000M	FSIV040P1M1000M
40	160 - 1600	408	356	350	FSIV040D1M1600M	FSIV040T1M1600M	FSIV040P1M1600M
40	200 - 2500	408	356	350	FSIV040D1M2500M	FSIV040T1M2500M	FSIV040P1M2500M
50	150 - 1600	418	356	350	FSIV050D1M1600M	FSIV050T1M1600M	FSIV050P1M1600M
50	200 - 2200	418	356	350	FSIV050D1M2200M	FSIV050T1M2200M	FSIV050P1M2200M
50	250 - 2500	418	356	350	FSIV050D1M2500M	FSIV050T1M2500M	FSIV050P1M2500M
63	250 - 2500	432	356	350	FSIV063D1M2500M	FSIV063T1M2500M	FSIV063P1M2500M
63	350 - 3500	432	356	350	FSIV063D1M3500M	FSIV063T1M3500M	FSIV063P1M3500M
63	500 - 5000	432	356	350	FSIV063D1M5000M	FSIV063T1M5000M	FSIV063P1M5000M
75	1000 - 8000	444	356	350	FSIV075D1M8000M	FSIV075T1M8000M	FSIV075P1M8000M
75	1000 - 10000	444	356	350	FSIV075D1M0010M	FSIV075T1M0010M	FSIV075P1M0010M
75	5000 - 25000	444	356	350	FSIV075D1M0025M	FSIV075T1M0025M	FSIV075P1M0025M

FS – STANDARD VERSION FLOWMETERS

NAOH 30% SCALE – SS FLOAT

LIQUID DENSITY: 1.33 KG/L – 20°C – ISO METRIC SOCKET UNIONS

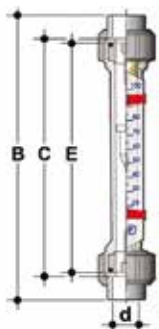

FSIV

Float: AISI 316 Stainless Steel

d	Flow rate range for NaOH 30% [l/h]	B	E	C	Transparent PVC-T code	Polysulfone code
25	6 - 125	394	350	356	FSIV025T3X0125	FSIV025P3X0125
25	10 - 240	394	350	356	FSIV025T3X0240	FSIV025P3X0240
25	25 - 425	394	350	356	FSIV025T3X0425	FSIV025P3X0425
25	35 - 725	394	350	356	FSIV025T3X0725	FSIV025P3X0725
32	10 - 240	400	350	356	FSIV032T3X0240	FSIV032P3X0240
32	20 - 420	400	350	356	FSIV032T3X0420	FSIV032P3X0420
32	25 - 700	400	350	356	FSIV032T3X0700	FSIV032P3X0700
32	50 - 1200	400	350	356	FSIV032T3X1200	FSIV032P3X1200
40	50 - 1150	408	350	356	FSIV040T3X1150	FSIV040P3X1150
40	100 - 1900	408	350	356	FSIV040T3X1900	FSIV040P3X1900
40	200 - 3200	408	350	356	FSIV040T3X3200	FSIV040P3X3200
50	100 - 1700	418	350	356	FSIV050T3X1700	FSIV050P3X1700
50	200 - 3000	418	350	356	FSIV050T3X3000	FSIV050P3X3000
50	200 - 3700	418	350	356	FSIV050T3X3700	FSIV050P3X3700
63	100 - 3000	432	350	356	FSIV063T3X3000	FSIV063P3X3000
63	250 - 4700	432	350	356	FSIV063T3X4700	FSIV063P3X4700
63	500 - 8500	432	350	356	FSIV063T3X8500	FSIV063P3X8500
75	1000 - 12000	444	350	356	FSIV075T3X0012	FSIV075P3X0012
75	1500 - 16500	444	350	356	FSIV075T3X0165	FSIV075P3X0165
75	8800 - 43000	444	350	356	FSIV075T3X0043	FSIV075P3X0043

Float: AISI 316 Stainless Steel + Magnet

d	Flow rate range for NaOH 30% [l/h]	B	E	C	Transparent PVC-T code	Polysulfone code
25	6 - 125	394	350	356	FSIV025T3X0125M	FSIV025P3X0125M
25	10 - 240	394	350	356	FSIV025T3X0240M	FSIV025P3X0240M
25	25 - 425	394	350	356	FSIV025T3X0425M	FSIV025P3X0425M
25	35 - 725	394	350	356	FSIV025T3X0725M	FSIV025P3X0725M
32	10 - 240	400	350	356	FSIV032T3X0240M	FSIV032P3X0240M
32	20 - 420	400	350	356	FSIV032T3X0420M	FSIV032P3X0420M
32	25 - 700	400	350	356	FSIV032T3X0700M	FSIV032P3X0700M
32	50 - 1200	400	350	356	FSIV032T3X1200M	FSIV032P3X1200M
40	50 - 1150	408	350	356	FSIV040T3X1150M	FSIV040P3X1150M
40	100 - 1900	408	350	356	FSIV040T3X1900M	FSIV040P3X1900M
40	200 - 3200	408	350	356	FSIV040T3X3200M	FSIV040P3X3200M
50	100 - 1700	418	350	356	FSIV050T3X1700M	FSIV050P3X1700M
50	200 - 3000	418	350	356	FSIV050T3X3000M	FSIV050P3X3000M
50	200 - 3700	418	350	356	FSIV050T3X3700M	FSIV050P3X3700M
63	100 - 3000	432	350	356	FSIV063T3X3000M	FSIV063P3X3000M
63	250 - 4700	432	350	356	FSIV063T3X4700M	FSIV063P3X4700M
63	500 - 8500	432	350	356	FSIV063T3X8500M	FSIV063P3X8500M
75	1000 - 12000	444	350	356	FSIV075T3X0012M	FSIV075P3X0012M
75	1500 - 16500	444	350	356	FSIV075T3X0165M	FSIV075P3X0165M
75	8800 - 43000	444	350	356	FSIV075T3X0043M	FSIV075P3X0043M

FS – STANDARD VERSION FLOWMETERS

NAOH 30% SCALE – PP FLOAT

LIQUID DENSITY: 1.33 KG/L - 20°C - ISO METRIC SOCKET UNIONS

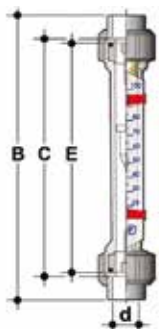

FSIV

Float: PP (Polypropylene) red

d	Flow rate range for NaOH 30% [l/h]	B	E	C	Transparent PVC-T code	Polysulfone code
25	2,5 - 54	394	350	356	FSIV025T3M0054	FSIV025P3M0054
25	6 - 115	394	350	356	FSIV025T3M0115	FSIV025P3M0115
25	11 - 235	394	350	356	FSIV025T3M0235	FSIV025P3M0235
25	28 - 410	394	350	356	FSIV025T3M0410	FSIV025P3M0410
32	6 - 125	400	350	356	FSIV032T3M0125	FSIV032P3M0125
32	10 - 200	400	350	356	FSIV032T3M0200	FSIV032P3M0200
32	11 - 395	400	350	356	FSIV032T3M0395	FSIV032P3M0395
32	25 - 650	400	350	356	FSIV032T3M0650	FSIV032P3M0650
40	25 - 600	408	350	356	FSIV040T3M0600	FSIV040P3M0600
40	55 - 1100	408	350	356	FSIV040T3M1100	FSIV040P3M1100
40	100 - 1700	408	350	356	FSIV040T3M1700	FSIV040P3M1700
50	50 - 1000	418	350	356	FSIV050T3M1000	FSIV050P3M1000
50	100 - 1500	418	350	356	FSIV050T3M1500	FSIV050P3M1500
50	120 - 1600	418	350	356	FSIV050T3M1600	FSIV050P3M1600
63	60 - 1700	432	350	356	FSIV063T3M1700	FSIV063P3M1700
63	90 - 2500	432	350	356	FSIV063T3M2500	FSIV063P3M2500
63	200 - 4000	432	350	356	FSIV063T3M4000	FSIV063P3M4000
75	670 - 6000	444	350	356	FSIV075T3M6000	FSIV075P3M6000
75	500 - 7500	444	350	356	FSIV075T3M7500	FSIV075P3M7500
75	4400 - 22000	444	350	356	FSIV075T3M0022	FSIV075P3M0022

Float: PP (Polypropylene) red + Magnet

d	Flow rate range for NaOH 30% [l/h]	B	E	C	Transparent PVC-T code	Polysulfone code
25	2,5 - 54	394	350	356	FSIV025T3M0054M	FSIV025P3M0054M
25	6 - 115	394	350	356	FSIV025T3M0115M	FSIV025P3M0115M
25	11 - 235	394	350	356	FSIV025T3M0235M	FSIV025P3M0235M
25	28 - 410	394	350	356	FSIV025T3M0410M	FSIV025P3M0410M
32	6 - 125	400	350	356	FSIV032T3M0125M	FSIV032P3M0125M
32	10 - 200	400	350	356	FSIV032T3M0200M	FSIV032P3M0200M
32	11 - 395	400	350	356	FSIV032T3M0395M	FSIV032P3M0395M
32	25 - 650	400	350	356	FSIV032T3M0650M	FSIV032P3M0650M
40	25 - 600	408	350	356	FSIV040T3M0600M	FSIV040P3M0600M
40	55 - 1100	408	350	356	FSIV040T3M1100M	FSIV040P3M1100M
40	100 - 1700	408	350	356	FSIV040T3M1700M	FSIV040P3M1700M
50	50 - 1000	418	350	356	FSIV050T3M1000M	FSIV050P3M1000M
50	100 - 1500	418	350	356	FSIV050T3M1500M	FSIV050P3M1500M
50	120 - 1600	418	350	356	FSIV050T3M1600M	FSIV050P3M1600M
63	60 - 1700	432	350	356	FSIV063T3M1700M	FSIV063P3M1700M
63	90 - 2500	432	350	356	FSIV063T3M2500M	FSIV063P3M2500M
63	200 - 4000	432	350	356	FSIV063T3M4000M	FSIV063P3M4000M
75	670 - 6000	444	350	356	FSIV075T3M6000M	FSIV075P3M6000M
75	500 - 7500	444	350	356	FSIV075T3M7500M	FSIV075P3M7500M
75	4400 - 22000	444	350	356	FSIV075T3M0022M	FSIV075P3M0022M

FS – STANDARD VERSION FLOWMETERS

NAOH 50% SCALE – SS FLOAT

LIQUID DENSITY: 1.53 KG/L – 20°C – ISO METRIC SOCKET UNIONS

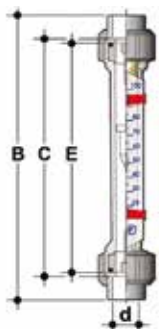

FSIV

Float: AISI 316 Stainless Steel

d	Flow rate range for NaOH 50% [l/h]	B	E	C	Transparent PVC-T code	Polysulfone code
25	1 - 27	394	350	356	FSIV025T5X0027	FSIV025P5X0027
25	2,5 - 70	394	350	356	FSIV025T5X0070	FSIV025P5X0070
25	5 - 170	394	350	356	FSIV025T5X0170	FSIV025P5X0170
25	15 - 350	394	350	356	FSIV025T5X0350	FSIV025P5X0350
32	2,5 - 65	400	350	356	FSIV032T5X0065	FSIV032P5X0065
32	5 - 145	400	350	356	FSIV032T5X0145	FSIV032P5X0145
32	10 - 330	400	350	356	FSIV032T5X0330	FSIV032P5X0330
32	25 - 675	400	350	356	FSIV032T5X0675	FSIV032P5X0675
40	25 - 550	408	350	356	FSIV040T5X0550	FSIV040P5X0550
40	50 - 1100	408	350	356	FSIV040T5X1100	FSIV040P5X1100
40	100 - 2000	408	350	356	FSIV040T5X2000	FSIV040P5X2000
50	50 - 1000	418	350	356	FSIV050T5X1000	FSIV050P5X1000
50	50 - 1900	418	350	356	FSIV050T5X1900	FSIV050P5X1900
50	100 - 2500	418	350	356	FSIV050T5X2500	FSIV050P5X2500
63	50 - 1800	432	350	356	FSIV063T5X1800	FSIV063P5X1800
63	100 - 3100	432	350	356	FSIV063T5X3100	FSIV063P5X3100
63	250 - 6000	432	350	356	FSIV063T5X6000	FSIV063P5X6000
75	250 - 9000	444	350	356	FSIV075T5X9000	FSIV075P5X9000
75	500 - 12500	444	350	356	FSIV075T5X0125	FSIV075P5X0125
75	8200 - 40000	444	350	356	FSIV075T5X0040	FSIV075P5X0040

Float: AISI 316 Stainless Steel + Magnet

d	Flow rate range for NaOH 50% [l/h]	B	E	C	Transparent PVC-T code	Polysulfone code
25	1 - 27	394	350	356	FSIV025T5X0027M	FSIV025P5X0027M
25	2,5 - 70	394	350	356	FSIV025T5X0070M	FSIV025P5X0070M
25	5 - 170	394	350	356	FSIV025T5X0170M	FSIV025P5X0170M
25	15 - 350	394	350	356	FSIV025T5X0350M	FSIV025P5X0350M
32	2,5 - 65	400	350	356	FSIV032T5X0065M	FSIV032P5X0065M
32	5 - 145	400	350	356	FSIV032T5X0145M	FSIV032P5X0145M
32	10 - 330	400	350	356	FSIV032T5X0330M	FSIV032P5X0330M
32	25 - 675	400	350	356	FSIV032T5X0675M	FSIV032P5X0675M
40	25 - 550	408	350	356	FSIV040T5X0550M	FSIV040P5X0550M
40	50 - 1100	408	350	356	FSIV040T5X1100M	FSIV040P5X1100M
40	100 - 2000	408	350	356	FSIV040T5X2000M	FSIV040P5X2000M
50	50 - 1000	418	350	356	FSIV050T5X1000M	FSIV050P5X1000M
50	50 - 1900	418	350	356	FSIV050T5X1900M	FSIV050P5X1900M
50	100 - 2500	418	350	356	FSIV050T5X2500M	FSIV050P5X2500M
63	50 - 1800	432	350	356	FSIV063T5X1800M	FSIV063P5X1800M
63	100 - 3100	432	350	356	FSIV063T5X3100M	FSIV063P5X3100M
63	250 - 6000	432	350	356	FSIV063T5X6000M	FSIV063P5X6000M
75	250 - 9000	444	350	356	FSIV075T5X9000M	FSIV075P5X9000M
75	500 - 12500	444	350	356	FSIV075T5X0125M	FSIV075P5X0125M
75	8200 - 40000	444	350	356	FSIV075T5X0040M	FSIV075P5X0040M

FS – STANDARD VERSION FLOWMETERS

NAOH 50% SCALE – PP FLOAT

LIQUID DENSITY: 1.53 KG/L - 20°C - ISO METRIC SOCKET UNIONS

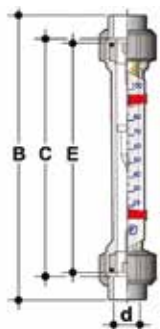

FSIV

Float: PP (Polypropylene) red

d	Flow rate range for NaOH 50% [l/h]	B	E	C	Transparent PVC-T code	Polysulfone code
25	0,5 - 9,5	394	350	356	FSIV025T5M0095	FSIV025P5M0095
25	1,5 - 23	394	350	356	FSIV025T5M0023	FSIV025P5M0023
25	3 - 65	394	350	356	FSIV025T5M0065	FSIV025P5M0065
25	7 - 145	394	350	356	FSIV025T5M0145	FSIV025P5M0145
32	1 - 20	400	350	356	FSIV032T5M0020	FSIV032P5M0020
32	2,5 - 50	400	350	356	FSIV032T5M0050	FSIV032P5M0050
32	5,5 - 130	400	350	356	FSIV032T5M0130	FSIV032P5M0130
32	10 - 260	400	350	356	FSIV032T5M0260	FSIV032P5M0260
40	10 - 200	408	350	356	FSIV040T5M0200	FSIV040P5M0200
40	20 - 500	408	350	356	FSIV040T5M0500	FSIV040P5M0500
40	25 - 950	408	350	356	FSIV040T5M0950	FSIV040P5M0950
50	25 - 425	418	350	356	FSIV050T5M0425	FSIV050P5M0425
50	25 - 800	418	350	356	FSIV050T5M0800	FSIV050P5M0800
50	40 - 950	418	350	356	FSIV050T5M0950	FSIV050P5M0950
63	30 - 800	432	350	356	FSIV063T5M0800	FSIV063P5M0800
63	40 - 1400	432	350	356	FSIV063T5M1400	FSIV063P5M1400
63	80 - 2500	432	350	356	FSIV063T5M2500	FSIV063P5M2500
75	330 - 3800	444	350	356	FSIV075T5M3800	FSIV075P5M3800
75	170 - 5200	444	350	356	FSIV075T5M5200	FSIV075P5M5200
75	4100 - 20000	444	350	356	FSIV075T5M0020	FSIV075P5M0020

Float: PP (Polypropylene) red + Magnet

d	Flow rate range for NaOH 50% [l/h]	B	E	C	Transparent PVC-T code	Polysulfone code
25	0,5 - 9,5	394	350	356	FSIV025T5M0095M	FSIV025P5M0095M
25	1,5 - 23	394	350	356	FSIV025T5M0023M	FSIV025P5M0023M
25	3 - 65	394	350	356	FSIV025T5M0065M	FSIV025P5M0065M
25	7 - 145	394	350	356	FSIV025T5M0145M	FSIV025P5M0145M
32	1 - 20	400	350	356	FSIV032T5M0020M	FSIV032P5M0020M
32	2,5 - 50	400	350	356	FSIV032T5M0050M	FSIV032P5M0050M
32	5,5 - 130	400	350	356	FSIV032T5M0130M	FSIV032P5M0130M
32	10 - 260	400	350	356	FSIV032T5M0260M	FSIV032P5M0260M
40	10 - 200	408	350	356	FSIV040T5M0200M	FSIV040P5M0200M
40	20 - 500	408	350	356	FSIV040T5M0500M	FSIV040P5M0500M
40	25 - 950	408	350	356	FSIV040T5M0950M	FSIV040P5M0950M
50	25 - 425	418	350	356	FSIV050T5M0425M	FSIV050P5M0425M
50	25 - 800	418	350	356	FSIV050T5M0800M	FSIV050P5M0800M
50	40 - 950	418	350	356	FSIV050T5M0950M	FSIV050P5M0950M
63	30 - 800	432	350	356	FSIV063T5M0800M	FSIV063P5M0800M
63	40 - 1400	432	350	356	FSIV063T5M1400M	FSIV063P5M1400M
63	80 - 2500	432	350	356	FSIV063T5M2500M	FSIV063P5M2500M
75	330 - 3800	444	350	356	FSIV075T5M3800M	FSIV075P5M3800M
75	170 - 5200	444	350	356	FSIV075T5M5200M	FSIV075P5M5200M
75	4100 - 20000	444	350	356	FSIV075T5M0020M	FSIV075P5M0020M

FS – STANDARD VERSION FLOWMETERS

HCL 30-33% SCALE - PP FLOAT

LIQUID DENSITY: 1.16 KG/L - 20°C - ISO METRIC SOCKET UNIONS

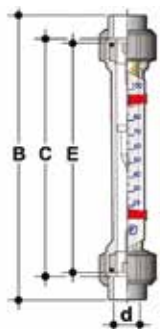

FSIV

Float: PP (Polypropylene) red

d	Flow rate range for HCl 30 - 33% [l/h]	B	E	C	Transparent PVC-T code	Polysulfone code
25	14 - 140	394	350	356	FSIV025T2M0140	FSIV025P2M0140
25	23 - 230	394	350	356	FSIV025T2M0230	FSIV025P2M0230
25	42 - 420	394	350	356	FSIV025T2M0420	FSIV025P2M0420
25	65 - 650	394	350	356	FSIV025T2M0650	FSIV025P2M0650
32	23 - 230	400	350	356	FSIV032T2M0230	FSIV032P2M0230
32	37 - 370	400	350	356	FSIV032T2M0370	FSIV032P2M0370
32	60 - 600	400	350	356	FSIV032T2M0600	FSIV032P2M0600
32	90 - 900	400	350	356	FSIV032T2M0900	FSIV032P2M0900
40	80 - 900	408	350	356	FSIV040T2M0900	FSIV040P2M0900
40	150 - 1500	408	350	356	FSIV040T2M1500	FSIV040P2M1500
40	200 - 2300	408	350	356	FSIV040T2M2300	FSIV040P2M2300
50	140 - 1500	418	350	356	FSIV050T2M1500	FSIV050P2M1500
50	190 - 2000	418	350	356	FSIV050T2M2000	FSIV050P2M2000
50	230 - 2300	418	350	356	FSIV050T2M2300	FSIV050P2M2300
63	230 - 2300	432	350	356	FSIV063T2M2300	FSIV063P2M2300
63	330 - 3200	432	350	356	FSIV063T2M3200	FSIV063P2M3200
63	470 - 4600	432	350	356	FSIV063T2M4600	FSIV063P2M4600
75	950 - 7500	444	350	356	FSIV075T2M7500	FSIV075P2M7500
75	930 - 9300	444	350	356	FSIV075T2M9300	FSIV075P2M9300
75	4700 - 23000	444	350	356	FSIV075T2M0023	FSIV075P2M0023

Float: PP (Polypropylene) red + Magnet

d	Flow rate range for HCl 30 - 33% [l/h]	B	E	C	Transparent PVC-T code	Polysulfone code
25	14 - 140	394	350	356	FSIV025T2M0140M	FSIV025P2M0140M
25	23 - 230	394	350	356	FSIV025T2M0230M	FSIV025P2M0230M
25	42 - 420	394	350	356	FSIV025T2M0420M	FSIV025P2M0420M
25	65 - 650	394	350	356	FSIV025T2M0650M	FSIV025P2M0650M
32	23 - 230	400	350	356	FSIV032T2M0230M	FSIV032P2M0230M
32	37 - 370	400	350	356	FSIV032T2M0370M	FSIV032P2M0370M
32	60 - 600	400	350	356	FSIV032T2M0600M	FSIV032P2M0600M
32	90 - 900	400	350	356	FSIV032T2M0900M	FSIV032P2M0900M
40	80 - 900	408	350	356	FSIV040T2M0900M	FSIV040P2M0900M
40	150 - 1500	408	350	356	FSIV040T2M1500M	FSIV040P2M1500M
40	200 - 2300	408	350	356	FSIV040T2M2300M	FSIV040P2M2300M
50	140 - 1500	418	350	356	FSIV050T2M1500M	FSIV050P2M1500M
50	190 - 2000	418	350	356	FSIV050T2M2000M	FSIV050P2M2000M
50	230 - 2300	418	350	356	FSIV050T2M2300M	FSIV050P2M2300M
63	230 - 2300	432	350	356	FSIV063T2M2300M	FSIV063P2M2300M
63	330 - 3200	432	350	356	FSIV063T2M3200M	FSIV063P2M3200M
63	470 - 4600	432	350	356	FSIV063T2M4600M	FSIV063P2M4600M
75	950 - 7500	444	350	356	FSIV075T2M7500M	FSIV075P2M7500M
75	930 - 9300	444	350	356	FSIV075T2M9300M	FSIV075P2M9300M
75	4700 - 23000	444	350	356	FSIV075T2M0023M	FSIV075P2M0023M

FS – STANDARD VERSION FLOWMETERS

AIR SCALE – PP FLOAT

ABSOLUTE PRESSURE: 1.013 BAR AT 20°C – ISO METRIC SOCKET UNIONS

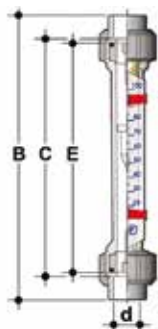

FSIV

Float: PP (Polypropylene) red

d	Flow rate range for air Nm ³ /h	B	E	C	Trogamid code
25	0,2 - 2,5	394	350	356	FSIV025DOM0025
25	0,3 - 4	394	350	356	FSIV025DOM0004
25	0,5 - 6,5	394	350	356	FSIV025DOM0065
25	1 - 10	394	350	356	FSIV025DOM0010
32	0,4 - 4	400	350	356	FSIV032DOM0004
32	0,5 - 6,5	400	350	356	FSIV032DOM0065
32	1 - 10	400	350	356	FSIV032DOM0010
32	1,5 - 16	400	350	356	FSIV032DOM0016
40	1,5 - 16	408	350	356	FSIV040DOM0016
40	2 - 25	408	350	356	FSIV040DOM0025
40	4 - 40	408	350	356	FSIV040DOM0040
50	2 - 25	418	350	356	FSIV050DOM0025
50	4 - 40	418	350	356	FSIV050DOM0040
50	5 - 50	418	350	356	FSIV050DOM0050
63	4 - 40	432	350	356	FSIV063DOM0040
63	6 - 64	432	350	356	FSIV063DOM0064
63	10 - 100	432	350	356	FSIV063DOM0100
75	15 - 140	444	350	356	FSIV075DOM0140
75	20 - 200	444	350	356	FSIV075DOM0200
75	50 - 500	444	350	356	FSIV075DOM0500

Float: PP (Polypropylene) red + Magnet

d	Flow rate range for air Nm ³ /h	B	E	C	Trogamid code
25	0,6 - 6	394	350	356	FSIV025DOM0006M
25	1 - 10	394	350	356	FSIV025DOM0010M
25	1,6 - 16	394	350	356	FSIV025DOM0016M
25	2,5 - 25	394	350	356	FSIV025DOM0025M
32	1 - 10	400	350	356	FSIV032DOM0010M
32	1,6 - 16	400	350	356	FSIV032DOM0016M
32	2,5 - 25	400	350	356	FSIV032DOM0025M
32	4 - 40	400	350	356	FSIV032DOM0040M
40	4 - 40	408	350	356	FSIV040DOM0040M
40	6 - 60	408	350	356	FSIV040DOM0060M
40	10 - 100	408	350	356	FSIV040DOM0100M
50	6 - 60	418	350	356	FSIV050DOM0060M
50	10 - 100	418	350	356	FSIV050DOM0100M
50	12,5 - 125	418	350	356	FSIV050DOM0125M
63	10 - 100	432	350	356	FSIV063DOM0100M
63	16 - 160	432	350	356	FSIV063DOM0160M
63	25 - 250	432	350	356	FSIV063DOM0250M
75	35 - 350	444	350	356	FSIV075DOM0350M
75	50 - 500	444	350	356	FSIV075DOM0500M

FS – STANDARD VERSION FLOWMETERS

H2O SCALE – SS FLOAT

LIQUID DENSITY: 1KG/L 20 °C – BSP SOCKET THREADED UNIONS

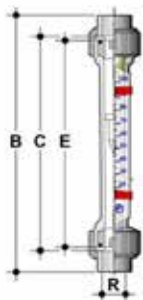

FSFV

Float: AISI 316 Stainless Steel

R	Flow rate range for H ₂ O [l/h]	B	E	C	Trogamid code	Transparent PVC-T code	Polysulfone code
3/4"	25-250	397	350	356	FSFV034D1X0250	FSFV034T1X0250	FSFV034P1X0250
3/4"	40-400	397	350	356	FSFV034D1X0400	FSFV034T1X0400	FSFV034P1X0400
3/4"	60-640	397	350	356	FSFV034D1X0640	FSFV034T1X0640	FSFV034P1X0640
3/4"	100-1000	397	350	356	FSFV034D1X1000	FSFV034T1X1000	FSFV034P1X1000
1"	40-400	401	350	356	FSFV100D1X0400	FSFV100T1X0400	FSFV100P1X0400
1"	60-640	401	350	356	FSFV100D1X0640	FSFV100T1X0640	FSFV100P1X0640
1"	100-1000	401	350	356	FSFV100D1X1000	FSFV100T1X1000	FSFV100P1X1000
1"	150-1600	401	350	356	FSFV100D1X1600	FSFV100T1X1600	FSFV100P1X1600
1 1/4"	150-1600	406	350	356	FSFV114D1X1600	FSFV114T1X1600	FSFV114P1X1600
1 1/4"	200-2500	406	350	356	FSFV114D1X2500	FSFV114T1X2500	FSFV114P1X2500
1 1/4"	400-4000	406	350	356	FSFV114D1X4000	FSFV114T1X4000	FSFV114P1X4000
1 1/2"	200-2500	413	350	356	FSFV112D1X2500	FSFV112T1X2500	FSFV112P1X2500
1 1/2"	400-4000	413	350	356	FSFV112D1X4000	FSFV112T1X4000	FSFV112P1X4000
1 1/2"	500-5000	413	350	356	FSFV112D1X5000	FSFV112T1X5000	FSFV112P1X5000
2"	400-4000	421	350	356	FSFV200D1X4000	FSFV200T1X4000	FSFV200P1X4000
2"	600-6000	421	350	356	FSFV200D1X6000	FSFV200T1X6000	FSFV200P1X6000
2"	1000-10000	421	350	356	FSFV200D1X0010	FSFV200T1X0010	FSFV200P1X0010
2 1/2"	1500-15000	444	350	356	FSFV212D1X0015	FSFV212T1X0015	FSFV212P1X0015
2 1/2"	2000-20000	444	350	356	FSFV212D1X0020	FSFV212T1X0020	FSFV212P1X0020
2 1/2"	10000-50000	444	350	356	FSFV212D1X0050	FSFV212T1X0050	FSFV212P1X0050

Float: AISI 316 Stainless Steel + Magnet

R	Flow rate range for H ₂ O [l/h]	B	E	C	Trogamid code	Transparent PVC-T code	Polysulfone code
3/4"	25-250	397	350	356	FSFV034D1X0250M	FSFV034T1X0250M	FSFV034P1X0250M
3/4"	40-400	397	350	356	FSFV034D1X0400M	FSFV034T1X0400M	FSFV034P1X0400M
3/4"	60-640	397	350	356	FSFV034D1X0640M	FSFV034T1X0640M	FSFV034P1X0640M
3/4"	100-1000	397	350	356	FSFV034D1X1000M	FSFV034T1X1000M	FSFV034P1X1000M
1"	40-400	401	350	356	FSFV100D1X0400M	FSFV100T1X0400M	FSFV100P1X0400M
1"	60-640	401	350	356	FSFV100D1X0640M	FSFV100T1X0640M	FSFV100P1X0640M
1"	100-1000	401	350	356	FSFV100D1X1000M	FSFV100T1X1000M	FSFV100P1X1000M
1"	150-1600	401	350	356	FSFV100D1X1600M	FSFV100T1X1600M	FSFV100P1X1600M
1 1/4"	150-1600	406	350	356	FSFV114D1X1600M	FSFV114T1X1600M	FSFV114P1X1600M
1 1/4"	200-2500	406	350	356	FSFV114D1X2500M	FSFV114T1X2500M	FSFV114P1X2500M
1 1/4"	400-4000	406	350	356	FSFV114D1X4000M	FSFV114T1X4000M	FSFV114P1X4000M
1 1/2"	200-2500	413	350	356	FSFV112D1X2500M	FSFV112T1X2500M	FSFV112P1X2500M
1 1/2"	400-4000	413	350	356	FSFV112D1X4000M	FSFV112T1X4000M	FSFV112P1X4000M
1 1/2"	500-5000	413	350	356	FSFV112D1X5000M	FSFV112T1X5000M	FSFV112P1X5000M
2"	400-4000	421	350	356	FSFV200D1X4000M	FSFV200T1X4000M	FSFV200P1X4000M
2"	600-6000	421	350	356	FSFV200D1X6000M	FSFV200T1X6000M	FSFV200P1X6000M
2"	1000-10000	421	350	356	FSFV200D1X0010M	FSFV200T1X0010M	FSFV200P1X0010M
2 1/2"	1500-15000	444	350	356	FSFV212D1X0015M	FSFV212T1X0015M	FSFV212P1X0015M
2 1/2"	2000-20000	444	350	356	FSFV212D1X0020M	FSFV212T1X0020M	FSFV212P1X0020M
2 1/2"	10000-50000	444	350	356	FSFV212D1X0050M	FSFV212T1X0050M	FSFV212P1X0050M

FS – STANDARD VERSION FLOWMETERS

H2O SCALE – PP FLOAT

LIQUID DENSITY: 1KG/L 20 °C – BSP SOCKET THREADED UNIONS

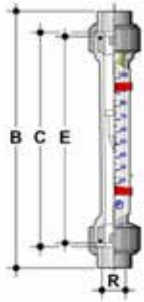

FSFV

Float: PP (Polypropylene) red

R	Flow rate range for H ₂ O [l/h]	B	C	E	Trogamid code	Transparent PVC-T code	Polysulfone code
3/4"	15 - 150	397	356	350	FSFV034D1M0150	FSFV034T1M0150	FSFV034P1M0150
3/4"	25 - 250	397	356	350	FSFV034D1M0250	FSFV034T1M0250	FSFV034P1M0250
3/4"	45 - 450	397	356	350	FSFV034D1M0450	FSFV034T1M0450	FSFV034P1M0450
3/4"	70 - 700	397	356	350	FSFV034D1M0700	FSFV034T1M0700	FSFV034P1M0700
1"	25 - 250	401	356	350	FSFV100D1M0250	FSFV100T1M0250	FSFV100P1M0250
1"	40 - 400	401	356	350	FSFV100D1M0400	FSFV100T1M0400	FSFV100P1M0400
1"	65 - 650	401	356	350	FSFV100D1M0650	FSFV100T1M0650	FSFV100P1M0650
1"	100 - 1000	401	356	350	FSFV100D1M1000	FSFV100T1M1000	FSFV100P1M1000
1 1/4"	100 - 1000	406	356	350	FSFV114D1M1000	FSFV114T1M1000	FSFV114P1M1000
1 1/4"	160 - 1600	406	356	350	FSFV114D1M1600	FSFV114T1M1600	FSFV114P1M1600
1 1/4"	200 - 2500	406	356	350	FSFV114D1M2500	FSFV114T1M2500	FSFV114P1M2500
1 1/2"	150 - 1600	413	356	350	FSFV112D1M1600	FSFV112T1M1600	FSFV112P1M1600
1 1/2"	200 - 2200	413	356	350	FSFV112D1M2200	FSFV112T1M2200	FSFV112P1M2200
1 1/2"	250 - 2500	413	356	350	FSFV112D1M2500	FSFV112T1M2500	FSFV112P1M2500
2"	250 - 2500	421	356	350	FSFV200D1M2500	FSFV200T1M2500	FSFV200P1M2500
2"	350 - 3500	421	356	350	FSFV200D1M3500	FSFV200T1M3500	FSFV200P1M3500
2"	500 - 5000	421	356	350	FSFV200D1M5000	FSFV200T1M5000	FSFV200P1M5000
2 1/2"	1000 - 8000	444	356	350	FSFV212D1M8000	FSFV212T1M8000	FSFV212P1M8000
2 1/2"	1000 - 10000	444	356	350	FSFV212D1M0010	FSFV212T1M0010	FSFV212P1M0010
2 1/2"	5000 - 25000	444	356	350	FSFV212D1M0025	FSFV212T1M0025	FSFV212P1M0025

Float: PP (Polypropylene) red + Magnet

R	Flow rate range for H ₂ O [l/h]	B	C	E	Trogamid code	Transparent PVC-T code	Polysulfone code
3/4"	15 - 150	397	356	350	FSFV034D1M0150M	FSFV034T1M0150M	FSFV034P1M0150M
3/4"	25 - 250	397	356	350	FSFV034D1M0250M	FSFV034T1M0250M	FSFV034P1M0250M
3/4"	45 - 450	397	356	350	FSFV034D1M0450M	FSFV034T1M0450M	FSFV034P1M0450M
3/4"	70 - 700	397	356	350	FSFV034D1M0700M	FSFV034T1M0700M	FSFV034P1M0700M
1"	25 - 250	401	356	350	FSFV100D1M0250M	FSFV100T1M0250M	FSFV100P1M0250M
1"	40 - 400	401	356	350	FSFV100D1M0400M	FSFV100T1M0400M	FSFV100P1M0400M
1"	65 - 650	401	356	350	FSFV100D1M0650M	FSFV100T1M0650M	FSFV100P1M0650M
1"	100 - 1000	401	356	350	FSFV100D1M1000M	FSFV100T1M1000M	FSFV100P1M1000M
1 1/4"	100 - 1000	406	356	350	FSFV114D1M1000M	FSFV114T1M1000M	FSFV114P1M1000M
1 1/4"	160 - 1600	406	356	350	FSFV114D1M1600M	FSFV114T1M1600M	FSFV114P1M1600M
1 1/4"	200 - 2500	406	356	350	FSFV114D1M2500M	FSFV114T1M2500M	FSFV114P1M2500M
1 1/2"	150 - 1600	413	356	350	FSFV112D1M1600M	FSFV112T1M1600M	FSFV112P1M1600M
1 1/2"	200 - 2200	413	356	350	FSFV112D1M2200M	FSFV112T1M2200M	FSFV112P1M2200M
1 1/2"	250 - 2500	413	356	350	FSFV112D1M2500M	FSFV112T1M2500M	FSFV112P1M2500M
2"	250 - 2500	421	356	350	FSFV200D1M2500M	FSFV200T1M2500M	FSFV200P1M2500M
2"	350 - 3500	421	356	350	FSFV200D1M3500M	FSFV200T1M3500M	FSFV200P1M3500M
2"	500 - 5000	421	356	350	FSFV200D1M5000M	FSFV200T1M5000M	FSFV200P1M5000M
2 1/2"	1000 - 8000	444	356	350	FSFV212D1M8000M	FSFV212T1M8000M	FSFV212P1M8000M
2 1/2"	1000 - 10000	444	356	350	FSFV212D1M0010M	FSFV212T1M0010M	FSFV212P1M0010M
2 1/2"	5000 - 25000	444	356	350	FSFV212D1M0025M	FSFV212T1M0025M	FSFV212P1M0025M

FS – STANDARD VERSION FLOWMETERS

NAOH 30% SCALE – SS FLOAT

LIQUID DENSITY: 1.33 KG/L – 20°C – BSP SOCKET THREADED UNIONS

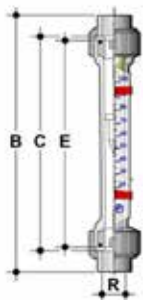

FSFV

Float: AISI 316 Stainless Steel

R	Flow rate range for NaOH 30% [l/h]	B	E	C	Transparent PVC-T code	Polysulfone code
3/4"	6 - 125	397	350	356	FSFV034T3X0125	FSFV034P3X0125
3/4"	10 - 240	397	350	356	FSFV034T3X0240	FSFV034P3X0240
3/4"	25 - 425	397	350	356	FSFV034T3X0425	FSFV034P3X0425
3/4"	35 - 725	397	350	356	FSFV034T3X0725	FSFV034P3X0725
1"	10 - 240	401	350	356	FSFV100T3X0240	FSFV100P3X0240
1"	20 - 420	401	350	356	FSFV100T3X0420	FSFV100P3X0420
1"	25 - 700	401	350	356	FSFV100T3X0700	FSFV100P3X0700
1"	50 - 1200	401	350	356	FSFV100T3X1200	FSFV100P3X1200
1 1/4"	50 - 1150	406	350	356	FSFV114T3X1150	FSFV114P3X1150
1 1/4"	100 - 1900	406	350	356	FSFV114T3X1900	FSFV114P3X1900
1 1/4"	200 - 3200	406	350	356	FSFV114T3X3200	FSFV114P3X3200
1 1/2"	100 - 1700	413	350	356	FSFV112T3X1700	FSFV112P3X1700
1 1/2"	200 - 3000	413	350	356	FSFV112T3X3000	FSFV112P3X3000
1 1/2"	200 - 3700	413	350	356	FSFV112T3X3700	FSFV112P3X3700
2"	100 - 3000	421	350	356	FSFV200T3X3000	FSFV200P3X3000
2"	250 - 4700	421	350	356	FSFV200T3X4700	FSFV200P3X4700
2"	500 - 8500	421	350	356	FSFV200T3X8500	FSFV200P3X8500
2 1/2"	1000 - 12000	444	350	356	FSFV212T3X0012	FSFV212P3X0012
2 1/2"	1500 - 16500	444	350	356	FSFV212T3X0165	FSFV212P3X0165
2 1/2"	8800 - 43000	444	350	356	FSFV212T3X0043	FSFV212P3X0043

Float: AISI 316 Stainless Steel + Magnet

R	Flow rate range for NaOH 30% [l/h]	B	E	C	Transparent PVC-T code	Polysulfone code
3/4"	6 - 125	397	350	356	FSFV034T3X0125M	FSFV034P3X0125M
3/4"	10 - 240	397	350	356	FSFV034T3X0240M	FSFV034P3X0240M
3/4"	25 - 425	397	350	356	FSFV034T3X0425M	FSFV034P3X0425M
3/4"	35 - 725	397	350	356	FSFV034T3X0725M	FSFV034P3X0725M
1"	10 - 240	401	350	356	FSFV100T3X0240M	FSFV100P3X0240M
1"	20 - 420	401	350	356	FSFV100T3X0420M	FSFV100P3X0420M
1"	25 - 700	401	350	356	FSFV100T3X0700M	FSFV100P3X0700M
1"	50 - 1200	401	350	356	FSFV100T3X1200M	FSFV100P3X1200M
1 1/4"	50 - 1150	406	350	356	FSFV114T3X1150M	FSFV114P3X1150M
1 1/4"	100 - 1900	406	350	356	FSFV114T3X1900M	FSFV114P3X1900M
1 1/4"	200 - 3200	406	350	356	FSFV114T3X3200M	FSFV114P3X3200M
1 1/2"	100 - 1700	413	350	356	FSFV112T3X1700M	FSFV112P3X1700M
1 1/2"	200 - 3000	413	350	356	FSFV112T3X3000M	FSFV112P3X3000M
1 1/2"	200 - 3700	413	350	356	FSFV112T3X3700M	FSFV112P3X3700M
2"	100 - 3000	421	350	356	FSFV200T3X3000M	FSFV200P3X3000M
2"	250 - 4700	421	350	356	FSFV200T3X4700M	FSFV200P3X4700M
2"	500 - 8500	421	350	356	FSFV200T3X8500M	FSFV200P3X8500M
2 1/2"	1000 - 12000	444	350	356	FSFV212T3X0012M	FSFV212P3X0012M
2 1/2"	1500 - 16500	444	350	356	FSFV212T3X0165M	FSFV212P3X0165M
2 1/2"	8800 - 43000	444	350	356	FSFV212T3X0043M	FSFV212P3X0043M

FS – STANDARD VERSION FLOWMETERS

NAOH 30% SCALE – PP FLOAT

LIQUID DENSITY: 1.33 KG/L - 20°C - BSP SOCKET THREADED UNIONS

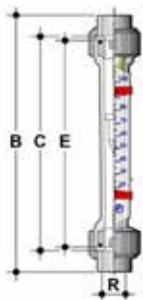

FSFV

Float: PP (Polypropylene) red

R	Flow rate range for NaOH 30% [l/h]	B	E	C	Transparent PVC-T code	Polysulfone code
3/4"	2,5 - 54	397	350	356	FSFV034T3M0054	FSFV034P3M0054
3/4"	6 - 115	397	350	356	FSFV034T3M0115	FSFV034P3M0115
3/4"	11 - 235	397	350	356	FSFV034T3M0235	FSFV034P3M0235
3/4"	28 - 410	397	350	356	FSFV034T3M0410	FSFV034P3M0410
1"	6 - 125	401	350	356	FSFV100T3M0125	FSFV100P3M0125
1"	10 - 200	401	350	356	FSFV100T3M0200	FSFV100P3M0200
1"	11 - 395	401	350	356	FSFV100T3M0395	FSFV100P3M0395
1"	25 - 650	401	350	356	FSFV100T3M0650	FSFV100P3M0650
1 1/4"	25 - 600	406	350	356	FSFV114T3M0600	FSFV114P3M0600
1 1/4"	55 - 1100	406	350	356	FSFV114T3M1100	FSFV114P3M1100
1 1/4"	100 - 1700	406	350	356	FSFV114T3M1700	FSFV114P3M1700
1 1/2"	50 - 1000	413	350	356	FSFV112T3M1000	FSFV112P3M1000
1 1/2"	100 - 1500	413	350	356	FSFV112T3M1500	FSFV112P3M1500
1 1/2"	120 - 1600	413	350	356	FSFV112T3M1600	FSFV112P3M1600
2"	60 - 1700	421	350	356	FSFV200T3M1700	FSFV200P3M1700
2"	90 - 2500	421	350	356	FSFV200T3M2500	FSFV200P3M2500
2"	200 - 4000	421	350	356	FSFV200T3M4000	FSFV200P3M4000
2 1/2"	670 - 6000	444	350	356	FSFV212T3M6000	FSFV212P3M6000
2 1/2"	500 - 7500	444	350	356	FSFV212T3M7500	FSFV212P3M7500
2 1/2"	4400 - 22000	444	350	356	FSFV212T3M0022	FSFV212P3M0022

Float: PP (Polypropylene) red + Magnet

R	Flow rate range for NaOH 30% [l/h]	B	E	C	Transparent PVC-T code	Polysulfone code
3/4"	2,5 - 54	397	350	356	FSFV034T3M0054M	FSFV034P3M0054M
3/4"	6 - 115	397	350	356	FSFV034T3M0115M	FSFV034P3M0115M
3/4"	11 - 235	397	350	356	FSFV034T3M0235M	FSFV034P3M0235M
3/4"	28 - 410	397	350	356	FSFV034T3M0410M	FSFV034P3M0410M
1"	6 - 125	401	350	356	FSFV100T3M0125M	FSFV100P3M0125M
1"	10 - 200	401	350	356	FSFV100T3M0200M	FSFV100P3M0200M
1"	11 - 395	401	350	356	FSFV100T3M0395M	FSFV100P3M0395M
1"	25 - 650	401	350	356	FSFV100T3M0650M	FSFV100P3M0650M
1 1/4"	25 - 600	406	350	356	FSFV114T3M0600M	FSFV114P3M0600M
1 1/4"	55 - 1100	406	350	356	FSFV114T3M1100M	FSFV114P3M1100M
1 1/4"	100 - 1700	406	350	356	FSFV114T3M1700M	FSFV114P3M1700M
1 1/2"	50 - 1000	413	350	356	FSFV112T3M1000M	FSFV112P3M1000M
1 1/2"	100 - 1500	413	350	356	FSFV112T3M1500M	FSFV112P3M1500M
1 1/2"	120 - 1600	413	350	356	FSFV112T3M1600M	FSFV112P3M1600M
2"	60 - 1700	421	350	356	FSFV200T3M1700M	FSFV200P3M1700M
2"	90 - 2500	421	350	356	FSFV200T3M2500M	FSFV200P3M2500M
2"	200 - 4000	421	350	356	FSFV200T3M4000M	FSFV200P3M4000M
2 1/2"	670 - 6000	444	350	356	FSFV212T3M6000M	FSFV212P3M6000M
2 1/2"	500 - 7500	444	350	356	FSFV212T3M7500M	FSFV212P3M7500M
2 1/2"	4400 - 22000	444	350	356	FSFV212T3M0022M	FSFV212P3M0022M

FS – STANDARD VERSION FLOWMETERS

NAOH 50% SCALE – SS FLOAT

LIQUID DENSITY: 1.53 KG/L – 20°C – BSP SOCKET THREADED UNIONS

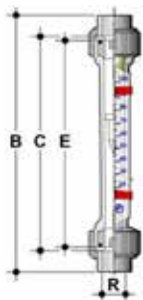

FSFV

Float: AISI 316 Stainless Steel

R	Flow rate range for NaOH 50% [l/h]	B	E	C	Transparent PVC-T code	Polysulfone code
3/4"	1 - 27	397	350	356	FSFV034T5X0027	FSFV034P5X0027
3/4"	2,5 - 70	397	350	356	FSFV034T5X0070	FSFV034P5X0070
3/4"	5 - 170	397	350	356	FSFV034T5X0170	FSFV034P5X0170
3/4"	15 - 350	397	350	356	FSFV034T5X0350	FSFV034P5X0350
1"	2,5 - 65	401	350	356	FSFV100T5X0065	FSFV100P5X0065
1"	5 - 145	401	350	356	FSFV100T5X0145	FSFV100P5X0145
1"	10 - 330	401	350	356	FSFV100T5X0330	FSFV100P5X0330
1"	25 - 675	401	350	356	FSFV100T5X0675	FSFV100P5X0675
1 1/4"	25 - 550	406	350	356	FSFV114T5X0550	FSFV114P5X0550
1 1/4"	50 - 1100	406	350	356	FSFV114T5X1100	FSFV114P5X1100
1 1/4"	100 - 2000	406	350	356	FSFV114T5X2000	FSFV114P5X2000
1 1/2"	50 - 1000	413	350	356	FSFV112T5X1000	FSFV112P5X1000
1 1/2"	50 - 1900	413	350	356	FSFV112T5X1900	FSFV112P5X1900
1 1/2"	100 - 2500	413	350	356	FSFV112T5X2500	FSFV112P5X2500
2"	50 - 1800	421	350	356	FSFV200T5X1800	FSFV200P5X1800
2"	100 - 3100	421	350	356	FSFV200T5X3100	FSFV200P5X3100
2"	250 - 6000	421	350	356	FSFV200T5X6000	FSFV200P5X6000
2 1/2"	250 - 9000	444	350	356	FSFV212T5X9000	FSFV212P5X9000
2 1/2"	500 - 12500	444	350	356	FSFV212T5X0125	FSFV212P5X0125
2 1/2"	8200 - 40000	444	350	356	FSFV212T5X0040	FSFV212P5X0040

Float: AISI 316 Stainless Steel + Magnet

R	Flow rate range for NaOH 50% [l/h]	B	E	C	Transparent PVC-T code	Polysulfone code
3/4"	1 - 27	397	350	356	FSFV034T5X0027M	FSFV034P5X0027M
3/4"	2,5 - 70	397	350	356	FSFV034T5X0070M	FSFV034P5X0070M
3/4"	5 - 170	397	350	356	FSFV034T5X0170M	FSFV034P5X0170M
3/4"	15 - 350	397	350	356	FSFV034T5X0350M	FSFV034P5X0350M
1"	2,5 - 65	401	350	356	FSFV100T5X0065M	FSFV100P5X0065M
1"	5 - 145	401	350	356	FSFV100T5X0145M	FSFV100P5X0145M
1"	10 - 330	401	350	356	FSFV100T5X0330M	FSFV100P5X0330M
1"	25 - 675	401	350	356	FSFV100T5X0675M	FSFV100P5X0675M
1 1/4"	25 - 550	406	350	356	FSFV114T5X0550M	FSFV114P5X0550M
1 1/4"	50 - 1100	406	350	356	FSFV114T5X1100M	FSFV114P5X1100M
1 1/4"	100 - 2000	406	350	356	FSFV114T5X2000M	FSFV114P5X2000M
1 1/2"	50 - 1000	413	350	356	FSFV112T5X1000M	FSFV112P5X1000M
1 1/2"	50 - 1900	413	350	356	FSFV112T5X1900M	FSFV112P5X1900M
1 1/2"	100 - 2500	413	350	356	FSFV112T5X2500M	FSFV112P5X2500M
2"	50 - 1800	421	350	356	FSFV200T5X1800M	FSFV200P5X1800M
2"	100 - 3100	421	350	356	FSFV200T5X3100M	FSFV200P5X3100M
2"	250 - 6000	421	350	356	FSFV200T5X6000M	FSFV200P5X6000M
2 1/2"	250 - 9000	444	350	356	FSFV212T5X9000M	FSFV212P5X9000M
2 1/2"	500 - 12500	444	350	356	FSFV212T5X0125M	FSFV212P5X0125M
2 1/2"	8200 - 40000	444	350	356	FSFV212T5X0040M	FSFV212P5X0040M

FS – STANDARD VERSION FLOWMETERS NAOH 50% SCALE – PP FLOAT

LIQUID DENSITY: 1.53 KG/L - 20°C - BSP SOCKET THREADED UNIONS

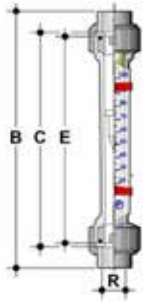

FSFV

Float: PP (Polypropylene) red

R	Flow rate range for NaOH 50% [l/h]	B	E	C	Transparent PVC-T code	Polysulfone code
3/4"	0,5 - 9,5	397	350	356	FSFV034T5M0095	FSFV034P5M0095
3/4"	1,5 - 23	397	350	356	FSFV034T5M0023	FSFV034P5M0023
3/4"	3 - 65	397	350	356	FSFV034T5M0065	FSFV034P5M0065
3/4"	7 - 145	397	350	356	FSFV034T5M0145	FSFV034P5M0145
1"	1 - 20	401	350	356	FSFV100T5M0020	FSFV100P5M0020
1"	2,5 - 50	401	350	356	FSFV100T5M0050	FSFV100P5M0050
1"	5,5 - 130	401	350	356	FSFV100T5M0130	FSFV100P5M0130
1"	10 - 260	401	350	356	FSFV100T5M0260	FSFV100P5M0260
1 1/4"	10 - 200	406	350	356	FSFV114T5M0200	FSFV114P5M0200
1 1/4"	20 - 500	406	350	356	FSFV114T5M0500	FSFV114P5M0500
1 1/4"	25 - 950	406	350	356	FSFV114T5M0950	FSFV114P5M0950
1 1/2"	25 - 425	413	350	356	FSFV112T5M0425	FSFV112P5M0425
1 1/2"	25 - 800	413	350	356	FSFV112T5M0800	FSFV112P5M0800
1 1/2"	40 - 950	413	350	356	FSFV112T5M0950	FSFV112P5M0950
2"	30 - 800	421	350	356	FSFV200T5M0800	FSFV200P5M0800
2"	40 - 1400	421	350	356	FSFV200T5M1400	FSFV200P5M1400
2"	80 - 2500	421	350	356	FSFV200T5M2500	FSFV200P5M2500
2 1/2"	330 - 3800	444	350	356	FSFV212T5M3800	FSFV212P5M3800
2 1/2"	170 - 5200	444	350	356	FSFV212T5M5200	FSFV212P5M5200
2 1/2"	4100 - 20000	444	350	356	FSFV212T5M0020	FSFV212P5M0020

Float: PP (Polypropylene) red + Magnet

R	Flow rate range for NaOH 50% [l/h]	B	E	C	Transparent PVC-T code	Polysulfone code
3/4"	0,5 - 9,5	397	350	356	FSFV034T5M0095M	FSFV034P5M0095M
3/4"	1,5 - 23	397	350	356	FSFV034T5M0023M	FSFV034P5M0023M
3/4"	3 - 65	397	350	356	FSFV034T5M0065M	FSFV034P5M0065M
3/4"	7 - 145	397	350	356	FSFV034T5M0145M	FSFV034P5M0145M
1"	1 - 20	401	350	356	FSFV100T5M0020M	FSFV100P5M0020M
1"	2,5 - 50	401	350	356	FSFV100T5M0050M	FSFV100P5M0050M
1"	5,5 - 130	401	350	356	FSFV100T5M0130M	FSFV100P5M0130M
1"	10 - 260	401	350	356	FSFV100T5M0260M	FSFV100P5M0260M
1 1/4"	10 - 200	406	350	356	FSFV114T5M0200M	FSFV114P5M0200M
1 1/4"	20 - 500	406	350	356	FSFV114T5M0500M	FSFV114P5M0500M
1 1/4"	25 - 950	406	350	356	FSFV114T5M0950M	FSFV114P5M0950M
1 1/2"	25 - 425	413	350	356	FSFV112T5M0425M	FSFV112P5M0425M
1 1/2"	25 - 800	413	350	356	FSFV112T5M0800M	FSFV112P5M0800M
1 1/2"	40 - 950	413	350	356	FSFV112T5M0950M	FSFV112P5M0950M
2"	30 - 800	421	350	356	FSFV200T5M0800M	FSFV200P5M0800M
2"	40 - 1400	421	350	356	FSFV200T5M1400M	FSFV200P5M1400M
2"	80 - 2500	421	350	356	FSFV200T5M2500M	FSFV200P5M2500M
2 1/2"	330 - 3800	444	350	356	FSFV212T5M3800M	FSFV212P5M3800M
2 1/2"	170 - 5200	444	350	356	FSFV212T5M5200M	FSFV212P5M5200M
2 1/2"	4100 - 20000	444	350	356	FSFV212T5M0020M	FSFV212P5M0020M

FS – STANDARD VERSION FLOWMETERS

HCL 30-33% SCALE – PP FLOAT

LIQUID DENSITY: 1.16 KG/L – 20°C – BSP SOCKET THREADED UNIONS

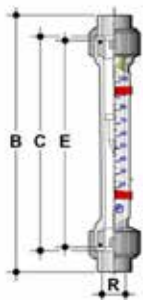

FSFV

Float: PP (Polypropylene) red

R	Flow rate range for HCl 30 – 33% [l/h]	B	E	C	Transparent PVC-T code	Polysulfone code
3/4"	14 – 140	397	350	356	FSFV034T2M0140	FSFV034P2M0140
3/4"	23 – 230	397	350	356	FSFV034T2M0230	FSFV034P2M0230
3/4"	42 – 420	397	350	356	FSFV034T2M0420	FSFV034P2M0420
3/4"	65 – 650	397	350	356	FSFV034T2M0650	FSFV034P2M0650
1"	23 – 230	401	350	356	FSFV100T2M0230	FSFV100P2M0230
1"	37 – 370	401	350	356	FSFV100T2M0370	FSFV100P2M0370
1"	60 – 600	401	350	356	FSFV100T2M0600	FSFV100P2M0600
1"	90 – 900	401	350	356	FSFV100T2M0900	FSFV100P2M0900
1 1/4"	80 – 900	406	350	356	FSFV114T2M0900	FSFV114P2M0900
1 1/4"	150 – 1500	406	350	356	FSFV114T2M1500	FSFV114P2M1500
1 1/4"	200 – 2300	406	350	356	FSFV114T2M2300	FSFV114P2M2300
1 1/2"	140 – 1500	413	350	356	FSFV112T2M1500	FSFV112P2M1500
1 1/2"	190 – 2000	413	350	356	FSFV112T2M2000	FSFV112P2M2000
1 1/2"	230 – 2300	413	350	356	FSFV112T2M2300	FSFV112P2M2300
2"	230 – 2300	421	350	356	FSFV200T2M2300	FSFV200P2M2300
2"	330 – 3200	421	350	356	FSFV200T2M3200	FSFV200P2M3200
2"	470 – 4600	421	350	356	FSFV200T2M4600	FSFV200P2M4600
2 1/2"	950 – 7500	444	350	356	FSFV212T2M7500	FSFV212P2M7500
2 1/2"	930 – 9300	444	350	356	FSFV212T2M9300	FSFV212P2M9300
2 1/2"	4700 – 23000	444	350	356	FSFV212T2M0023	FSFV212P2M0023

Float: PP (Polypropylene) red + Magnet

R	Flow rate range for HCl 30 – 33% [l/h]	B	E	C	Transparent PVC-T code	Polysulfone code
3/4"	14 – 140	397	350	356	FSFV034T2M0140M	FSFV034P2M0140M
3/4"	23 – 230	397	350	356	FSFV034T2M0230M	FSFV034P2M0230M
3/4"	42 – 420	397	350	356	FSFV034T2M0420M	FSFV034P2M0420M
3/4"	65 – 650	397	350	356	FSFV034T2M0650M	FSFV034P2M0650M
1"	23 – 230	401	350	356	FSFV100T2M0230M	FSFV100P2M0230M
1"	37 – 370	401	350	356	FSFV100T2M0370M	FSFV100P2M0370M
1"	60 – 600	401	350	356	FSFV100T2M0600M	FSFV100P2M0600M
1"	90 – 900	401	350	356	FSFV100T2M0900M	FSFV100P2M0900M
1 1/4"	80 – 900	406	350	356	FSFV114T2M0900M	FSFV114P2M0900M
1 1/4"	150 – 1500	406	350	356	FSFV114T2M1500M	FSFV114P2M1500M
1 1/4"	200 – 2300	406	350	356	FSFV114T2M2300M	FSFV114P2M2300M
1 1/2"	140 – 1500	413	350	356	FSFV112T2M1500M	FSFV112P2M1500M
1 1/2"	190 – 2000	413	350	356	FSFV112T2M2000M	FSFV112P2M2000M
1 1/2"	230 – 2300	413	350	356	FSFV112T2M2300M	FSFV112P2M2300M
2"	230 – 2300	421	350	356	FSFV200T2M2300M	FSFV200P2M2300M
2"	330 – 3200	421	350	356	FSFV200T2M3200M	FSFV200P2M3200M
2"	470 – 4600	421	350	356	FSFV200T2M4600M	FSFV200P2M4600M
2 1/2"	950 – 7500	444	350	356	FSFV212T2M7500M	FSFV212P2M7500M
2 1/2"	930 – 9300	444	350	356	FSFV212T2M9300M	FSFV212P2M9300M
2 1/2"	4700 – 23000	444	350	356	FSFV212T2M0023M	FSFV212P2M0023M

FS – STANDARD VERSION FLOWMETERS

AIR SCALE – PP FLOAT

ABSOLUTE PRESSURE: 1.013 BAR AT 20°C – BSP SOCKET THREADED UNIONS

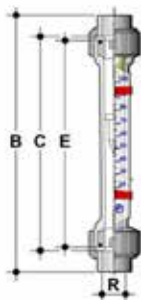

FSFV

Float: PP (Polypropylene) red

R	Flow rate range for air Nm ³ /h	B	E	C	Trogamid code
3/4"	0,2 – 2,5	397	350	356	FSFV034DOM0025
3/4"	0,3 – 4	397	350	356	FSFV034DOM0004
3/4"	0,5 – 6,5	397	350	356	FSFV034DOM0065
3/4"	1 – 10	397	350	356	FSFV034DOM0010
1"	0,4 – 4	401	350	356	FSFV100D0M0004
1"	0,5 – 6,5	401	350	356	FSFV100D0M0065
1"	1 – 10	401	350	356	FSFV100D0M0010
1"	1,5 – 16	401	350	356	FSFV100D0M0016
1 1/4"	1,5 – 16	406	350	356	FSFV114DOM0016
1 1/4"	2 – 25	406	350	356	FSFV114DOM0025
1 1/4"	4 – 40	406	350	356	FSFV114DOM0040
1 1/2"	2 – 25	413	350	356	FSFV112D0M0025
1 1/2"	4 – 40	413	350	356	FSFV112D0M0040
1 1/2"	5 – 50	413	350	356	FSFV112D0M0050
2"	4 – 40	421	350	356	FSFV200D0M0040
2"	6 – 64	421	350	356	FSFV200D0M0064
2"	10 – 100	421	350	356	FSFV200D0M0100
2 1/2"	15 – 140	444	350	356	FSFV212D0M0140
2 1/2"	20 – 200	444	350	356	FSFV212D0M0200
2 1/2"	50 – 500	444	350	356	FSFV212D0M0500

Float: PP (Polypropylene) red + Magnet

R	Flow rate range for air Nm ³ /h	B	E	C	Trogamid code
3/4"	0,6 – 6	397	350	356	FSFV034DOM0006M
3/4"	1 – 10	397	350	356	FSFV034DOM0010M
3/4"	1,6 – 16	397	350	356	FSFV034DOM0016M
3/4"	2,5 – 25	397	350	356	FSFV034DOM0025M
1"	1 – 10	401	350	356	FSFV100D0M0010M
1"	1,6 – 16	401	350	356	FSFV100D0M0016M
1"	2,5 – 25	401	350	356	FSFV100D0M0025M
1"	4 – 40	401	350	356	FSFV100D0M0040M
1 1/4"	4 – 40	406	350	356	FSFV114DOM0040M
1 1/4"	6 – 60	406	350	356	FSFV114DOM0060M
1 1/4"	10 – 100	406	350	356	FSFV114DOM0100M
1 1/2"	6 – 60	413	350	356	FSFV112D0M0060M
1 1/2"	10 – 100	413	350	356	FSFV112D0M0100M
1 1/2"	12,5 – 125	413	350	356	FSFV112D0M0125M
2"	10 – 100	421	350	356	FSFV200D0M0100M
2"	16 – 160	421	350	356	FSFV200D0M0160M
2"	25 – 250	421	350	356	FSFV200D0M0250M
2 1/2"	35 – 350	444	350	356	FSFV212D0M0350M
2 1/2"	50 – 500	444	350	356	FSFV212D0M0500M

FC – COMPACT VERSION FLOWMETERS

H2O SCALE – SS FLOAT

LIQUID DENSITY: 1KG/L 20 °C – ISO METRIC SOCKET UNIONS

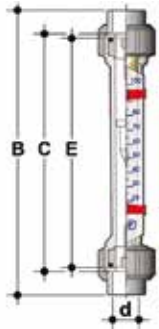

FCIV

Float: AISI 316 Stainless Steel

D	Flow rate range for H ₂ O [l/h]	B	E	C	Trogamid code	Transparent PVC-T code	Polysulfone code
16	3 - 30	199	165	171	FCIV016D1X0030	FCIV016T1X0030	FCIV016P1X0030
16	4 - 40	199	165	171	FCIV016D1X0040	FCIV016T1X0040	FCIV016P1X0040
16	10 - 100	199	165	171	FCIV016D1X0100	FCIV016T1X0100	FCIV016P1X0100
16	20 - 200	199	165	171	FCIV016D1X0200	FCIV016T1X0200	FCIV016P1X0200
16	30 - 300	199	165	171	FCIV016D1X0300	FCIV016T1X0300	FCIV016P1X0300
20	5 - 50	208	170	176	FCIV020D1X0050	FCIV020T1X0050	FCIV020P1X0050
20	10 - 100	208	170	176	FCIV020D1X0100	FCIV020T1X0100	FCIV020P1X0100
20	15 - 160	208	170	176	FCIV020D1X0160	FCIV020T1X0160	FCIV020P1X0160
20	20 - 250	208	170	176	FCIV020D1X0250	FCIV020T1X0250	FCIV020P1X0250
20	35 - 350	208	170	176	FCIV020D1X0350	FCIV020T1X0350	FCIV020P1X0350
20	60 - 600	208	170	176	FCIV020D1X0600	FCIV020T1X0600	FCIV020P1X0600
25	15 - 150	229	185	191	FCIV025D1X0150	FCIV025T1X0150	FCIV025P1X0150
25	25 - 250	229	185	191	FCIV025D1X0250	FCIV025T1X0250	FCIV025P1X0250
25	40 - 400	229	185	191	FCIV025D1X0400	FCIV025T1X0400	FCIV025P1X0400
25	50 - 600	229	185	191	FCIV025D1X0600	FCIV025T1X0600	FCIV025P1X0600
25	100 - 1100	229	185	191	FCIV025D1X1100	FCIV025T1X1100	FCIV025P1X1100
32	40 - 400	250	200	206	FCIV032D1X0400	FCIV032T1X0400	FCIV032P1X0400
32	50 - 600	250	200	206	FCIV032D1X0600	FCIV032T1X0600	FCIV032P1X0600
32	100 - 1000	250	200	206	FCIV032D1X1000	FCIV032T1X1000	FCIV032P1X1000
32	150 - 1500	250	200	206	FCIV032D1X1500	FCIV032T1X1500	FCIV032P1X1500

Float: AISI 316 Stainless Steel + Magnet

D	Flow rate range for H ₂ O [l/h]	B	E	C	Trogamid code	Transparent PVC-T code	Polysulfone code
16	3 - 30	199	165	171	FCIV016D1X0030M	FCIV016T1X0030M	FCIV016P1X0030M
16	4 - 40	199	165	171	FCIV016D1X0040M	FCIV016T1X0040M	FCIV016P1X0040M
16	10 - 100	199	165	171	FCIV016D1X0100M	FCIV016T1X0100M	FCIV016P1X0100M
16	20 - 200	199	165	171	FCIV016D1X0200M	FCIV016T1X0200M	FCIV016P1X0200M
16	30 - 300	199	165	171	FCIV016D1X0300M	FCIV016T1X0300M	FCIV016P1X0300M
20	5 - 50	208	170	176	FCIV020D1X0050M	FCIV020T1X0050M	FCIV020P1X0050M
20	10 - 100	208	170	176	FCIV020D1X0100M	FCIV020T1X0100M	FCIV020P1X0100M
20	15 - 160	208	170	176	FCIV020D1X0160M	FCIV020T1X0160M	FCIV020P1X0160M
20	20 - 250	208	170	176	FCIV020D1X0250M	FCIV020T1X0250M	FCIV020P1X0250M
20	35 - 350	208	170	176	FCIV020D1X0350M	FCIV020T1X0350M	FCIV020P1X0350M
20	60 - 600	208	170	176	FCIV020D1X0600M	FCIV020T1X0600M	FCIV020P1X0600M
25	15 - 150	229	185	191	FCIV025D1X0150M	FCIV025T1X0150M	FCIV025P1X0150M
25	25 - 250	229	185	191	FCIV025D1X0250M	FCIV025T1X0250M	FCIV025P1X0250M
25	40 - 400	229	185	191	FCIV025D1X0400M	FCIV025T1X0400M	FCIV025P1X0400M
25	50 - 600	229	185	191	FCIV025D1X0600M	FCIV025T1X0600M	FCIV025P1X0600M
25	100 - 1100	229	185	191	FCIV025D1X1100M	FCIV025T1X1100M	FCIV025P1X1100M
32	40 - 400	250	200	206	FCIV032D1X0400M	FCIV032T1X0400M	FCIV032P1X0400M
32	50 - 600	250	200	206	FCIV032D1X0600M	FCIV032T1X0600M	FCIV032P1X0600M
32	100 - 1000	250	200	206	FCIV032D1X1000M	FCIV032T1X1000M	FCIV032P1X1000M
32	150 - 1500	250	200	206	FCIV032D1X1500M	FCIV032T1X1500M	FCIV032P1X1500M

FC – COMPACT VERSION FLOWMETERS

H2O SCALE – PP FLOAT

LIQUID DENSITY: 1KG/L 20 °C – ISO METRIC SOCKET UNIONS

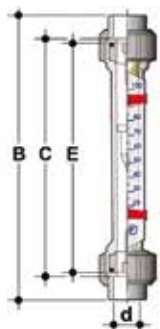

FCIV

Float: PP (Polypropylene) red

FC SERIES

D	Flow rate range for H ₂ O [l/h]	B	E	C	Trogamid code	Transparent PVC-T code	Polysulfone code
16	1,5 - 15	199	165	171	FCIV016D1M0015	FCIV016T1M0015	FCIV016P1M0015
16	2 - 20	199	165	171	FCIV016D1M0020	FCIV016T1M0020	FCIV016P1M0020
16	5 - 50	199	165	171	FCIV016D1M0050	FCIV016T1M0050	FCIV016P1M0050
16	10 - 100	199	165	171	FCIV016D1M0100	FCIV016T1M0100	FCIV016P1M0100
16	15 - 150	199	165	171	FCIV016D1M0150	FCIV016T1M0150	FCIV016P1M0150
20	2 - 25	208	170	176	FCIV020D1M0025	FCIV020T1M0025	FCIV020P1M0025
20	5 - 50	208	170	176	FCIV020D1M0050	FCIV020T1M0050	FCIV020P1M0050
20	10 - 100	208	170	176	FCIV020D1M0100	FCIV020T1M0100	FCIV020P1M0100
20	15 - 150	208	170	176	FCIV020D1M0150	FCIV020T1M0150	FCIV020P1M0150
20	20 - 200	208	170	176	FCIV020D1M0200	FCIV020T1M0200	FCIV020P1M0200
20	30 - 320	208	170	176	FCIV020D1M0320	FCIV020T1M0320	FCIV020P1M0320
25	8 - 80	229	185	191	FCIV025D1M0080	FCIV025T1M0080	FCIV025P1M0080
25	15 - 150	229	185	191	FCIV025D1M0150	FCIV025T1M0150	FCIV025P1M0150
25	20 - 200	229	185	191	FCIV025D1M0200	FCIV025T1M0200	FCIV025P1M0200
25	30 - 350	229	185	191	FCIV025D1M0350	FCIV025T1M0350	FCIV025P1M0350
25	50 - 650	229	185	191	FCIV025D1M0650	FCIV025T1M0650	FCIV025P1M0650
32	20 - 200	250	200	206	FCIV032D1M0200	FCIV032T1M0200	FCIV032P1M0200
32	30 - 300	250	200	206	FCIV032D1M0300	FCIV032T1M0300	FCIV032P1M0300
32	60 - 600	250	200	206	FCIV032D1M0600	FCIV032T1M0600	FCIV032P1M0600
32	100 - 1000	250	200	206	FCIV032D1M1000	FCIV032T1M1000	FCIV032P1M1000

Float: PP (Polypropylene) red + Magnet

D	Flow rate range for H ₂ O [l/h]	B	E	C	Trogamid code	Transparent PVC-T code	Polysulfone code
16	1,5 - 15	199	165	171	FCIV016D1M0015M	FCIV016T1M0015M	FCIV016P1M0015M
16	2 - 20	199	165	171	FCIV016D1M0020M	FCIV016T1M0020M	FCIV016P1M0020M
16	5 - 50	199	165	171	FCIV016D1M0050M	FCIV016T1M0050M	FCIV016P1M0050M
16	10 - 100	199	165	171	FCIV016D1M0100M	FCIV016T1M0100M	FCIV016P1M0100M
16	15 - 150	199	165	171	FCIV016D1M0150M	FCIV016T1M0150M	FCIV016P1M0150M
20	2 - 25	208	170	176	FCIV020D1M0025M	FCIV020T1M0025M	FCIV020P1M0025M
20	5 - 50	208	170	176	FCIV020D1M0050M	FCIV020T1M0050M	FCIV020P1M0050M
20	10 - 100	208	170	176	FCIV020D1M0100M	FCIV020T1M0100M	FCIV020P1M0100M
20	15 - 150	208	170	176	FCIV020D1M0150M	FCIV020T1M0150M	FCIV020P1M0150M
20	20 - 200	208	170	176	FCIV020D1M0200M	FCIV020T1M0200M	FCIV020P1M0200M
20	30 - 320	208	170	176	FCIV020D1M0320M	FCIV020T1M0320M	FCIV020P1M0320M
25	8 - 80	229	185	191	FCIV025D1M0080M	FCIV025T1M0080M	FCIV025P1M0080M
25	15 - 150	229	185	191	FCIV025D1M0150M	FCIV025T1M0150M	FCIV025P1M0150M
25	20 - 200	229	185	191	FCIV025D1M0200M	FCIV025T1M0200M	FCIV025P1M0200M
25	30 - 350	229	185	191	FCIV025D1M0350M	FCIV025T1M0350M	FCIV025P1M0350M
25	50 - 650	229	185	191	FCIV025D1M0650M	FCIV025T1M0650M	FCIV025P1M0650M
32	20 - 200	250	200	206	FCIV032D1M0200M	FCIV032T1M0200M	FCIV032P1M0200M
32	30 - 300	250	200	206	FCIV032D1M0300M	FCIV032T1M0300M	FCIV032P1M0300M
32	60 - 600	250	200	206	FCIV032D1M0600M	FCIV032T1M0600M	FCIV032P1M0600M
32	100 - 1000	250	200	206	FCIV032D1M1000M	FCIV032T1M1000M	FCIV032P1M1000M

FC – COMPACT VERSION FLOWMETERS

NAOH 30% SCALE – SS FLOAT

LIQUID DENSITY: 1.33 KG/L – 20°C – ISO METRIC SOCKET UNIONS

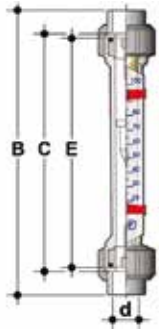

FCIV

Float: AISI 316 Stainless Steel

d	Flow rate range for NaOH 30% [l/h]	B	E	C	Transparent PVC-T code	Polysulfone code
16	0,5 - 8,5	199	165	171	FCIV016T3X0085	FCIV016P3X0085
16	2,5 - 40	199	165	171	FCIV016T3X0040	FCIV016P3X0040
16	10 - 120	199	165	171	FCIV016T3X0120	FCIV016P3X0120
16	15 - 180	199	165	171	FCIV016T3X0180	FCIV016P3X0180
20	2,5 - 37,5	208	170	176	FCIV020T3X0375	FCIV020P3X0375
20	4 - 75	208	170	176	FCIV020T3X0075	FCIV020P3X0075
20	5 - 140	208	170	176	FCIV020T3X0140	FCIV020P3X0140
20	9 - 220	208	170	176	FCIV020T3X0220	FCIV020P3X0220
20	24 - 360	208	170	176	FCIV020T3X0360	FCIV020P3X0360
25	6 - 135	229	185	191	FCIV025T3X0135	FCIV025P3X0135
25	13 - 230	229	185	191	FCIV025T3X0230	FCIV025P3X0230
25	20 - 350	229	185	191	FCIV025T3X0350	FCIV025P3X0350
25	25 - 600	229	185	191	FCIV025T3X0600	FCIV025P3X0600
32	10 - 220	250	200	206	FCIV032T3X0220	FCIV032P3X0220
32	20 - 350	250	200	206	FCIV032T3X0350	FCIV032P3X0350
32	25 - 650	250	200	206	FCIV032T3X0650	FCIV032P3X0650
32	50 - 1000	250	200	206	FCIV032T3X1000	FCIV032P3X1000

Float: AISI 316 Stainless Steel + Magnet

d	Flow rate range for NaOH 30% [l/h]	B	E	C	Transparent PVC-T code	Polysulfone code
16	0,5 - 8,5	199	165	171	FCIV016T3X0085M	FCIV016P3X0085M
16	2,5 - 40	199	165	171	FCIV016T3X0040M	FCIV016P3X0040M
16	10 - 120	199	165	171	FCIV016T3X0120M	FCIV016P3X0120M
16	15 - 180	199	165	171	FCIV016T3X0180M	FCIV016P3X0180M
20	2,5 - 37,5	208	170	176	FCIV020T3X0375M	FCIV020P3X0375M
20	4 - 75	208	170	176	FCIV020T3X0075M	FCIV020P3X0075M
20	5 - 140	208	170	176	FCIV020T3X0140M	FCIV020P3X0140M
20	9 - 220	208	170	176	FCIV020T3X0220M	FCIV020P3X0220M
20	24 - 360	208	170	176	FCIV020T3X0360M	FCIV020P3X0360M
25	6 - 135	229	185	191	FCIV025T3X0135M	FCIV025P3X0135M
25	13 - 230	229	185	191	FCIV025T3X0230M	FCIV025P3X0230M
25	20 - 350	229	185	191	FCIV025T3X0350M	FCIV025P3X0350M
25	25 - 600	229	185	191	FCIV025T3X0600M	FCIV025P3X0600M
32	10 - 220	250	200	206	FCIV032T3X0220M	FCIV032P3X0220M
32	20 - 350	250	200	206	FCIV032T3X0350M	FCIV032P3X0350M
32	25 - 650	250	200	206	FCIV032T3X0650M	FCIV032P3X0650M
32	50 - 1000	250	200	206	FCIV032T3X1000M	FCIV032P3X1000M

FC – COMPACT VERSION FLOWMETERS

NAOH 30% SCALE – PP FLOAT

LIQUID DENSITY: 1.33 KG/L - 20°C - ISO METRIC SOCKET UNIONS

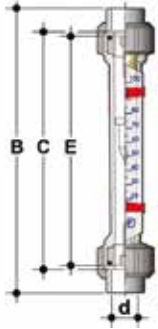

FCIV

Float: PP (Polypropylene) red

d	Flow rate range for NaOH 30% [l/h]	B	E	C	Transparent PVC-T code	Polysulfone code
16	0,25 - 3	199	165	171	FCIV016T3M0003	FCIV016P3M0003
16	1 - 17	199	165	171	FCIV016T3M0017	FCIV016P3M0017
16	2,5 - 45	199	165	171	FCIV016T3M0045	FCIV016P3M0045
16	5 - 75	199	165	171	FCIV016T3M0075	FCIV016P3M0075
20	1 - 12,5	208	170	176	FCIV020T3M0125	FCIV020P3M0125
20	2 - 34	208	170	176	FCIV020T3M0034	FCIV020P3M0034
20	2,5 - 63	208	170	176	FCIV020T3M0063	FCIV020P3M0063
20	5 - 104	208	170	176	FCIV020T3M0104	FCIV020P3M0104
20	10 - 170	208	170	176	FCIV020T3M0170	FCIV020P3M0170
25	3,5 - 60	229	185	191	FCIV025T3M0060	FCIV025P3M0060
25	5 - 92	229	185	191	FCIV025T3M0092	FCIV025P3M0092
25	8 - 165	229	185	191	FCIV025T3M0165	FCIV025P3M0165
25	20 - 380	229	185	191	FCIV025T3M0380	FCIV025P3M0380
32	5 - 90	250	200	206	FCIV032T3M0090	FCIV032P3M0090
32	7,5 - 150	250	200	206	FCIV032T3M0150	FCIV032P3M0150
32	20 - 360	250	200	206	FCIV032T3M0360	FCIV032P3M0360
32	25 - 650	250	200	206	FCIV032T3M0650	FCIV032P3M0650

Float: PP (Polypropylene) red + Magnet

d	Flow rate range for NaOH 30% [l/h]	B	E	C	Transparent PVC-T code	Polysulfone code
16	0,25 - 3	199	165	171	FCIV016T3M0003M	FCIV016P3M0003M
16	1 - 17	199	165	171	FCIV016T3M0017M	FCIV016P3M0017M
16	2,5 - 45	199	165	171	FCIV016T3M0045M	FCIV016P3M0045M
16	5 - 75	199	165	171	FCIV016T3M0075M	FCIV016P3M0075M
20	1 - 12,5	208	170	176	FCIV020T3M0125M	FCIV020P3M0125M
20	2 - 34	208	170	176	FCIV020T3M0034M	FCIV020P3M0034M
20	2,5 - 63	208	170	176	FCIV020T3M0063M	FCIV020P3M0063M
20	5 - 104	208	170	176	FCIV020T3M0104M	FCIV020P3M0104M
20	10 - 170	208	170	176	FCIV020T3M0170M	FCIV020P3M0170M
25	3,5 - 60	229	185	191	FCIV025T3M0060M	FCIV025P3M0060M
25	5 - 92	229	185	191	FCIV025T3M0092M	FCIV025P3M0092M
25	8 - 165	229	185	191	FCIV025T3M0165M	FCIV025P3M0165M
25	20 - 380	229	185	191	FCIV025T3M0380M	FCIV025P3M0380M
32	5 - 90	250	200	206	FCIV032T3M0090M	FCIV032P3M0090M
32	7,5 - 150	250	200	206	FCIV032T3M0150M	FCIV032P3M0150M
32	20 - 360	250	200	206	FCIV032T3M0360M	FCIV032P3M0360M
32	25 - 650	250	200	206	FCIV032T3M0650M	FCIV032P3M0650M

FC – COMPACT VERSION FLOWMETERS

NAOH 50% SCALE – SS FLOAT

LIQUID DENSITY: 1.53 KG/L - 20°C - ISO METRIC SOCKET UNIONS

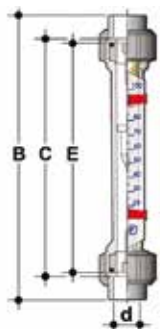

FCIV

Float: AISI 316 Stainless Steel

d	Flow rate range for NaOH 50% [l/h]	B	E	C	Transparent PVC-T code	Polysulfone code
16	0.05-1.4	199	165	171	FCIV016T5X0014	FCIV016P5X0014
16	0.5-8	199	165	171	FCIV016T5X0008	FCIV016P5X0008
16	2.5-40	199	165	171	FCIV016T5X0040	FCIV016P5X0040
16	4-55	199	165	171	FCIV016T5X0055	FCIV016P5X0055
20	0.25-6.5	208	170	176	FCIV020T5X0065	FCIV020P5X0065
20	1-15	208	170	176	FCIV020T5X0015	FCIV020P5X0015
20	2-36	208	170	176	FCIV020T5X0036	FCIV020P5X0036
20	4-75	208	170	176	FCIV020T5X0075	FCIV020P5X0075
20	6-140	208	170	176	FCIV020T5X0140	FCIV020P5X0140
25	2.5-30	229	185	191	FCIV025T5X0030	FCIV025P5X0030
25	3-65	229	185	191	FCIV025T5X0065	FCIV025P5X0065
25	3.5-135	229	185	191	FCIV025T5X0135	FCIV025P5X0135
25	20-320	229	185	191	FCIV025T5X0320	FCIV025P5X0320
32	2.5-55	250	200	206	FCIV032T5X0055	FCIV032P5X0055
32	5-125	250	200	206	FCIV032T5X0125	FCIV032P5X0125
32	20-300	250	200	206	FCIV032T5X0300	FCIV032P5X0300
32	25-600	250	200	206	FCIV032T5X0600	FCIV032P5X0600

Float: AISI 316 Stainless Steel + Magnet

d	Flow rate range for NaOH 50% [l/h]	B	E	C	Transparent PVC-T code	Polysulfone code
16	0.05-1.4	199	165	171	FCIV016T5X0014M	FCIV016P5X0014M
16	0.5-8	199	165	171	FCIV016T5X0008M	FCIV016P5X0008M
16	2.5-40	199	165	171	FCIV016T5X0040M	FCIV016P5X0040M
16	4-55	199	165	171	FCIV016T5X0055M	FCIV016P5X0055M
20	0.25-6.5	208	170	176	FCIV020T5X0065M	FCIV020P5X0065M
20	1-15	208	170	176	FCIV020T5X0015M	FCIV020P5X0015M
20	2-36	208	170	176	FCIV020T5X0036M	FCIV020P5X0036M
20	4-75	208	170	176	FCIV020T5X0075M	FCIV020P5X0075M
20	6-140	208	170	176	FCIV020T5X0140M	FCIV020P5X0140M
25	2.5-30	229	185	191	FCIV025T5X0030M	FCIV025P5X0030M
25	3-65	229	185	191	FCIV025T5X0065M	FCIV025P5X0065M
25	3.5-135	229	185	191	FCIV025T5X0135M	FCIV025P5X0135M
25	20-320	229	185	191	FCIV025T5X0320M	FCIV025P5X0320M
32	2.5-55	250	200	206	FCIV032T5X0055M	FCIV032P5X0055M
32	5-125	250	200	206	FCIV032T5X0125M	FCIV032P5X0125M
32	20-300	250	200	206	FCIV032T5X0300M	FCIV032P5X0300M
32	25-600	250	200	206	FCIV032T5X0600M	FCIV032P5X0600M

FC – COMPACT VERSION FLOWMETERS

NAOH 50% SCALE – PP FLOAT

LIQUID DENSITY: 1.53 KG/L - 20°C - ISO METRIC SOCKET UNIONS

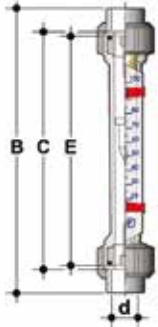

FCIV

Float: PP (Polypropylene) red

FC SERIES

d	Flow rate range for NaOH 50% [l/h]	B	E	C	Transparent PVC-T code	Polysulfone code
16	0,025 - 0,5	199	165	171	FCIV016T5M0005	FCIV016P5M0005
16	0,25 - 2,75	199	165	171	FCIV016T5M0275	FCIV016P5M0275
16	0,5 - 9	199	165	171	FCIV016T5M0009	FCIV016P5M0009
16	1 - 21	199	165	171	FCIV016T5M0021	FCIV016P5M0021
20	0,1 - 2	208	170	176	FCIV020T5M0002	FCIV020P5M0002
20	0,25 - 5,5	208	170	176	FCIV020T5M0055	FCIV020P5M0055
20	0,5 - 12,5	208	170	176	FCIV020T5M0125	FCIV020P5M0125
20	2 - 25,5	208	170	176	FCIV020T5M0255	FCIV020P5M0255
20	2,5 - 47,5	208	170	176	FCIV020T5M0475	FCIV020P5M0475
25	1 - 10	229	185	191	FCIV025T5M0010	FCIV025P5M0010
25	1 - 19	229	185	191	FCIV025T5M0019	FCIV025P5M0019
25	2 - 45	229	185	191	FCIV025T5M0045	FCIV025P5M0045
25	4 - 130	229	185	191	FCIV025T5M0130	FCIV025P5M0130
32	1 - 15	250	200	206	FCIV032T5M0015	FCIV032P5M0015
32	2 - 40	250	200	206	FCIV032T5M0040	FCIV032P5M0040
32	5 - 110	250	200	206	FCIV032T5M0110	FCIV032P5M0110
32	10 - 260	250	200	206	FCIV032T5M0260	FCIV032P5M0260

Float: PP (Polypropylene) red + Magnet

d	Flow rate range for NaOH 50% [l/h]	B	E	C	Transparent PVC-T code	Polysulfone code
16	0,025 - 0,5	199	165	171	FCIV016T5M0005M	FCIV016P5M0005M
16	0,25 - 2,75	199	165	171	FCIV016T5M0275M	FCIV016P5M0275M
16	0,5 - 9	199	165	171	FCIV016T5M0009M	FCIV016P5M0009M
16	1 - 21	199	165	171	FCIV016T5M0021M	FCIV016P5M0021M
20	0,1 - 2	208	170	176	FCIV020T5M0002M	FCIV020P5M0002M
20	0,25 - 5,5	208	170	176	FCIV020T5M0055M	FCIV020P5M0055M
20	0,5 - 12,5	208	170	176	FCIV020T5M0125M	FCIV020P5M0125M
20	2 - 25,5	208	170	176	FCIV020T5M0255M	FCIV020P5M0255M
20	2,5 - 47,5	208	170	176	FCIV020T5M0475M	FCIV020P5M0475M
25	1 - 10	229	185	191	FCIV025T5M0010M	FCIV025P5M0010M
25	1 - 19	229	185	191	FCIV025T5M0019M	FCIV025P5M0019M
25	2 - 45	229	185	191	FCIV025T5M0045M	FCIV025P5M0045M
25	4 - 130	229	185	191	FCIV025T5M0130M	FCIV025P5M0130M
32	1 - 15	250	200	206	FCIV032T5M0015M	FCIV032P5M0015M
32	2 - 40	250	200	206	FCIV032T5M0040M	FCIV032P5M0040M
32	5 - 110	250	200	206	FCIV032T5M0110M	FCIV032P5M0110M
32	10 - 260	250	200	206	FCIV032T5M0260M	FCIV032P5M0260M

FC – COMPACT VERSION FLOWMETERS

HCL 30-33% SCALE – PP FLOAT

LIQUID DENSITY: 1.16 KG/L – 20°C – ISO METRIC SOCKET UNIONS

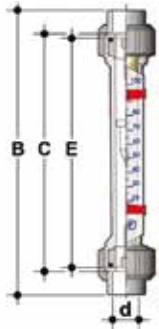

FCIV

Float: PP (Polypropylene) red

d	Flow rate range for HCl 30 – 33% [l/h]	B	E	C	Transparent PVC-T code	Polysulfone code
16	1,4 – 14	199	165	171	FCIV016T2M0014	FCIV016P2M0014
16	2 – 18	199	165	171	FCIV016T2M0018	FCIV016P2M0018
16	5 – 45	199	165	171	FCIV016T2M0045	FCIV016P2M0045
16	10 – 90	199	165	171	FCIV016T2M0090	FCIV016P2M0090
16	14 – 140	199	165	171	FCIV016T2M0140	FCIV016P2M0140
20	2 – 23	208	170	176	FCIV020T2M0023	FCIV020P2M0023
20	5 – 45	208	170	176	FCIV020T2M0045	FCIV020P2M0045
20	10 – 90	208	170	176	FCIV020T2M0090	FCIV020P2M0090
20	14 – 140	208	170	176	FCIV020T2M0140	FCIV020P2M0140
20	19 – 185	208	170	176	FCIV020T2M0185	FCIV020P2M0185
20	30 – 300	208	170	176	FCIV020T2M0300	FCIV020P2M0300
25	7,5 – 75	229	185	191	FCIV025T2M0075	FCIV025P2M0075
25	14 – 140	229	185	191	FCIV025T2M0140	FCIV025P2M0140
25	19 – 185	229	185	191	FCIV025T2M0185	FCIV025P2M0185
25	30 – 325	229	185	191	FCIV025T2M0325	FCIV025P2M0325
25	45 – 600	229	185	191	FCIV025T2M0600	FCIV025P2M0600
32	19 – 185	250	200	206	FCIV032T2M0185	FCIV032P2M0185
32	28 – 280	250	200	206	FCIV032T2M0280	FCIV032P2M0280
32	55 – 550	250	200	206	FCIV032T2M0550	FCIV032P2M0550
32	90 – 900	250	200	206	FCIV032T2M0900	FCIV032P2M0900

Float: PP (Polypropylene) red + Magnet

d	Flow rate range for HCl 30 – 33% [l/h]	B	E	C	Transparent PVC-T code	Polysulfone code
16	1,4 – 14	199	165	171	FCIV016T2M0014M	FCIV016P2M0014M
16	2 – 18	199	165	171	FCIV016T2M0018M	FCIV016P2M0018M
16	5 – 45	199	165	171	FCIV016T2M0045M	FCIV016P2M0045M
16	10 – 90	199	165	171	FCIV016T2M0090M	FCIV016P2M0090M
16	14 – 140	199	165	171	FCIV016T2M0140M	FCIV016P2M0140M
20	2 – 23	208	170	176	FCIV020T2M0023M	FCIV020P2M0023M
20	5 – 45	208	170	176	FCIV020T2M0045M	FCIV020P2M0045M
20	10 – 90	208	170	176	FCIV020T2M0090M	FCIV020P2M0090M
20	14 – 140	208	170	176	FCIV020T2M0140M	FCIV020P2M0140M
20	19 – 185	208	170	176	FCIV020T2M0185M	FCIV020P2M0185M
20	30 – 300	208	170	176	FCIV020T2M0300M	FCIV020P2M0300M
25	7,5 – 75	229	185	191	FCIV025T2M0075M	FCIV025P2M0075M
25	14 – 140	229	185	191	FCIV025T2M0140M	FCIV025P2M0140M
25	19 – 185	229	185	191	FCIV025T2M0185M	FCIV025P2M0185M
25	30 – 325	229	185	191	FCIV025T2M0325M	FCIV025P2M0325M
25	45 – 600	229	185	191	FCIV025T2M0600M	FCIV025P2M0600M
32	19 – 185	250	200	206	FCIV032T2M0185M	FCIV032P2M0185M
32	28 – 280	250	200	206	FCIV032T2M0280M	FCIV032P2M0280M
32	55 – 550	250	200	206	FCIV032T2M0550M	FCIV032P2M0550M
32	90 – 900	250	200	206	FCIV032T2M0900M	FCIV032P2M0900M

FC – COMPACT VERSION FLOWMETERS

AIR SCALE – PP FLOAT

ABSOLUTE PRESSURE: 1.013 BAR AT 20°C – ISO METRIC SOCKET UNIONS

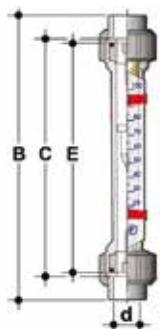

FCIV

Float: PP (Polypropylene) red

FC SERIES

d	Flow rate range for air Nm ³ /h	B	E	C	Trogamid code
16	0,025 - 0,25	199	165	171	FCIV016DOM0025
16	0,04 - 0,4	199	165	171	FCIV016DOM0004
16	0,1 - 1	199	165	171	FCIV016DOM0001
16	0,2 - 2	199	165	171	FCIV016DOM0002
20	0,045 - 0,45	208	170	176	FCIV020DOM00045
20	0,09 - 0,9	208	170	176	FCIV020DOM0009
20	0,15 - 1,5	208	170	176	FCIV020DOM0015
20	0,25 - 2,5	208	170	176	FCIV020DOM0025
20	0,38 - 3,8	208	170	176	FCIV020DOM0038
20	0,4 - 4,8	208	170	176	FCIV020DOM00048
25	0,12 - 1,2	229	185	191	FCIV025DOM0012
25	0,3 - 2,5	229	185	191	FCIV025DOM0025
25	0,45 - 4,5	229	185	191	FCIV025DOM00045
25	0,6 - 6,5	229	185	191	FCIV025DOM00065
25	1 - 10	229	185	191	FCIV025DOM0010
32	0,6 - 4	250	200	206	FCIV032DOM0004
32	0,7 - 7	250	200	206	FCIV032DOM0007
32	1,1 - 11	250	200	206	FCIV032DOM0011
32	2 - 14	250	200	206	FCIV032DOM0014

Float: PP (Polypropylene) red + Magnet

d	Flow rate range for air Nm ³ /h	B	E	C	Trogamid code
20	0,12 - 1,2	208	170	176	FCIV020DOM0012M
20	0,2 - 2	208	170	176	FCIV020DOM0002M
20	0,35 - 3,5	208	170	176	FCIV020DOM00035M
20	0,6 - 6	208	170	176	FCIV020DOM0006M
20	1,0 - 10	208	170	176	FCIV020DOM0010M
20	1,25 - 12,5	208	170	176	FCIV020DOM0125M
25	0,3 - 3	229	185	191	FCIV025DOM0003M
25	0,6 - 6	229	185	191	FCIV025DOM0006M
25	1,2 - 12	229	185	191	FCIV025DOM0012M
25	1,6 - 16	229	185	191	FCIV025DOM0016M
25	2 - 24	229	185	191	FCIV025DOM0024M
32	1 - 10	250	200	206	FCIV032DOM0010M
32	1,7 - 17	250	200	206	FCIV032DOM0017M
32	2,7 - 27	250	200	206	FCIV032DOM0027M
32	3,5 - 35	250	200	206	FCIV032DOM0035M

FC – COMPACT VERSION FLOWMETERS

H2O SCALE – SS FLOAT

LIQUID DENSITY: 1KG/L 20 °C – BSP SOCKET THREADED UNIONS

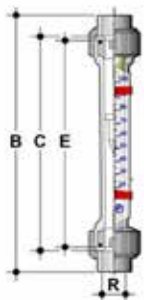

FCFV

Float: AISI 316 Stainless Steel

R	Flow rate range for H ₂ O [l/h]	B	E	C	Trogamid code	Transparent PVC-T code	Polysulfone code
3/8"	3 - 30	198	171	165	FCFV038D1X0030	FCFV038T1X0030	FCFV038P1X0030
3/8"	4 - 40	198	171	165	FCFV038D1X0040	FCFV038T1X0040	FCFV038P1X0040
3/8"	10 - 100	198	171	165	FCFV038D1X0100	FCFV038T1X0100	FCFV038P1X0100
3/8"	20 - 200	198	171	165	FCFV038D1X0200	FCFV038T1X0200	FCFV038P1X0200
3/8"	30 - 300	198	171	165	FCFV038D1X0300	FCFV038T1X0300	FCFV038P1X0300
1/2"	5 - 50	212	176	170	FCFV012D1X0050	FCFV012T1X0050	FCFV012P1X0050
1/2"	10 - 100	212	176	170	FCFV012D1X0100	FCFV012T1X0100	FCFV012P1X0100
1/2"	15 - 160	212	176	170	FCFV012D1X0160	FCFV012T1X0160	FCFV012P1X0160
1/2"	20 - 250	212	176	170	FCFV012D1X0250	FCFV012T1X0250	FCFV012P1X0250
1/2"	35 - 350	212	176	170	FCFV012D1X0350	FCFV012T1X0350	FCFV012P1X0350
1/2"	60 - 600	212	176	170	FCFV012D1X0600	FCFV012T1X0600	FCFV012P1X0600
3/4"	15 - 150	232	191	185	FCFV034D1X0150	FCFV034T1X0150	FCFV034P1X0150
3/4"	25 - 250	232	191	185	FCFV034D1X0250	FCFV034T1X0250	FCFV034P1X0250
3/4"	40 - 400	232	191	185	FCFV034D1X0400	FCFV034T1X0400	FCFV034P1X0400
3/4"	50 - 600	232	191	185	FCFV034D1X0600	FCFV034T1X0600	FCFV034P1X0600
3/4"	100 - 1100	232	191	185	FCFV034D1X1100	FCFV034T1X1100	FCFV034P1X1100
1"	40 - 400	251	206	200	FCFV100D1X0400	FCFV100T1X0400	FCFV100P1X0400
1"	50 - 600	251	206	200	FCFV100D1X0600	FCFV100T1X0600	FCFV100P1X0600
1"	100 - 1000	251	206	200	FCFV100D1X1000	FCFV100T1X1000	FCFV100P1X1000
1"	150 - 1500	251	206	200	FCFV100D1X1500	FCFV100T1X1500	FCFV100P1X1500

Float: AISI 316 Stainless Steel + Magnet

R	Flow rate range for H ₂ O [l/h]	B	E	C	Trogamid code	Transparent PVC-T code	Polysulfone code
3/8"	3 - 30	198	171	165	FCFV038D1X0030M	FCFV038T1X0030M	FCFV038P1X0030M
3/8"	4 - 40	198	171	165	FCFV038D1X0040M	FCFV038T1X0040M	FCFV038P1X0040M
3/8"	10 - 100	198	171	165	FCFV038D1X0100M	FCFV038T1X0100M	FCFV038P1X0100M
3/8"	20 - 200	198	171	165	FCFV038D1X0200M	FCFV038T1X0200M	FCFV038P1X0200M
3/8"	30 - 300	198	171	165	FCFV038D1X0300M	FCFV038T1X0300M	FCFV038P1X0300M
1/2"	5 - 50	212	176	170	FCFV012D1X0050M	FCFV012T1X0050M	FCFV012P1X0050M
1/2"	10 - 100	212	176	170	FCFV012D1X0100M	FCFV012T1X0100M	FCFV012P1X0100M
1/2"	15 - 160	212	176	170	FCFV012D1X0160M	FCFV012T1X0160M	FCFV012P1X0160M
1/2"	20 - 250	212	176	170	FCFV012D1X0250M	FCFV012T1X0250M	FCFV012P1X0250M
1/2"	35 - 350	212	176	170	FCFV012D1X0350M	FCFV012T1X0350M	FCFV012P1X0350M
1/2"	60 - 600	212	176	170	FCFV012D1X0600M	FCFV012T1X0600M	FCFV012P1X0600M
3/4"	15 - 150	232	191	185	FCFV034D1X0150M	FCFV034T1X0150M	FCFV034P1X0150M
3/4"	25 - 250	232	191	185	FCFV034D1X0250M	FCFV034T1X0250M	FCFV034P1X0250M
3/4"	40 - 400	232	191	185	FCFV034D1X0400M	FCFV034T1X0400M	FCFV034P1X0400M
3/4"	50 - 600	232	191	185	FCFV034D1X0600M	FCFV034T1X0600M	FCFV034P1X0600M
3/4"	100 - 1100	232	191	185	FCFV034D1X1100M	FCFV034T1X1100M	FCFV034P1X1100M
1"	40 - 400	251	206	200	FCFV100D1X0400M	FCFV100T1X0400M	FCFV100P1X0400M
1"	50 - 600	251	206	200	FCFV100D1X0600M	FCFV100T1X0600M	FCFV100P1X0600M
1"	100 - 1000	251	206	200	FCFV100D1X1000M	FCFV100T1X1000M	FCFV100P1X1000M
1"	150 - 1500	251	206	200	FCFV100D1X1500M	FCFV100T1X1500M	FCFV100P1X1500M

FC – COMPACT VERSION FLOWMETERS

H2O SCALE – PP FLOAT

LIQUID DENSITY: 1KG/L 20 °C – BSP SOCKET THREADED UNIONS

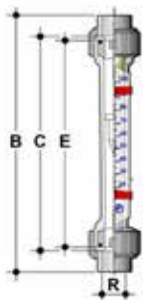

FCFV

Float: PP (Polypropylene) red

FC SERIES

R	Flow rate range for H ₂ O [l/h]	B	E	C	Trogamid code	Transparent PVC-T code	Polysulfone code
3/8"	1,5 - 15	198	171	165	FCFV038D1M0015	FCFV038T1M0015	FCFV038P1M0015
3/8"	2 - 20	198	171	165	FCFV038D1M0020	FCFV038T1M0020	FCFV038P1M0020
3/8"	5 - 50	198	171	165	FCFV038D1M0050	FCFV038T1M0050	FCFV038P1M0050
3/8"	10 - 100	198	171	165	FCFV038D1M0100	FCFV038T1M0100	FCFV038P1M0100
3/8"	15 - 150	198	171	165	FCFV038D1M0150	FCFV038T1M0150	FCFV038P1M0150
1/2"	2 - 25	212	176	170	FCFV012D1M0025	FCFV012T1M0025	FCFV012P1M0025
1/2"	5 - 50	212	176	170	FCFV012D1M0050	FCFV012T1M0050	FCFV012P1M0050
1/2"	10 - 100	212	176	170	FCFV012D1M0100	FCFV012T1M0100	FCFV012P1M0100
1/2"	15 - 150	212	176	170	FCFV012D1M0150	FCFV012T1M0150	FCFV012P1M0150
1/2"	20 - 200	212	176	170	FCFV012D1M0200	FCFV012T1M0200	FCFV012P1M0200
1/2"	30 - 320	212	176	170	FCFV012D1M0320	FCFV012T1M0320	FCFV012P1M0320
3/4"	8 - 80	232	191	185	FCFV034D1M0080	FCFV034T1M0080	FCFV034P1M0080
3/4"	15 - 150	232	191	185	FCFV034D1M0150	FCFV034T1M0150	FCFV034P1M0150
3/4"	20 - 200	232	191	185	FCFV034D1M0200	FCFV034T1M0200	FCFV034P1M0200
3/4"	30 - 350	232	191	185	FCFV034D1M0350	FCFV034T1M0350	FCFV034P1M0350
3/4"	50 - 650	232	191	185	FCFV034D1M0650	FCFV034T1M0650	FCFV034P1M0650
1"	20 - 200	251	206	200	FCFV100D1M0200	FCFV100T1M0200	FCFV100P1M0200
1"	30 - 300	251	206	200	FCFV100D1M0300	FCFV100T1M0300	FCFV100P1M0300
1"	60 - 600	251	206	200	FCFV100D1M0600	FCFV100T1M0600	FCFV100P1M0600
1"	100 - 1000	251	206	200	FCFV100D1M1000	FCFV100T1M1000	FCFV100P1M1000

Float: PP (Polypropylene) red + Magnet

R	Flow rate range for H ₂ O [l/h]	B	E	C	Trogamid code	Transparent PVC-T code	Polysulfone code
3/8"	1,5 - 15	198	171	165	FCFV038D1M0015M	FCFV038T1M0015M	FCFV038P1M0015M
3/8"	2 - 20	198	171	165	FCFV038D1M0020M	FCFV038T1M0020M	FCFV038P1M0020M
3/8"	5 - 50	198	171	165	FCFV038D1M0050M	FCFV038T1M0050M	FCFV038P1M0050M
3/8"	10 - 100	198	171	165	FCFV038D1M0100M	FCFV038T1M0100M	FCFV038P1M0100M
3/8"	15 - 150	198	171	165	FCFV038D1M0150M	FCFV038T1M0150M	FCFV038P1M0150M
1/2"	2 - 25	212	176	170	FCFV012D1M0025M	FCFV012T1M0025M	FCFV012P1M0025M
1/2"	5 - 50	212	176	170	FCFV012D1M0050M	FCFV012T1M0050M	FCFV012P1M0050M
1/2"	10 - 100	212	176	170	FCFV012D1M0100M	FCFV012T1M0100M	FCFV012P1M0100M
1/2"	15 - 150	212	176	170	FCFV012D1M0150M	FCFV012T1M0150M	FCFV012P1M0150M
1/2"	20 - 200	212	176	170	FCFV012D1M0200M	FCFV012T1M0200M	FCFV012P1M0200M
1/2"	30 - 320	212	176	170	FCFV012D1M0320M	FCFV012T1M0320M	FCFV012P1M0320M
3/4"	8 - 80	232	191	185	FCFV034D1M0080M	FCFV034T1M0080M	FCFV034P1M0080M
3/4"	15 - 150	232	191	185	FCFV034D1M0150M	FCFV034T1M0150M	FCFV034P1M0150M
3/4"	20 - 200	232	191	185	FCFV034D1M0200M	FCFV034T1M0200M	FCFV034P1M0200M
3/4"	30 - 350	232	191	185	FCFV034D1M0350M	FCFV034T1M0350M	FCFV034P1M0350M
3/4"	50 - 650	232	191	185	FCFV034D1M0650M	FCFV034T1M0650M	FCFV034P1M0650M
1"	20 - 200	251	206	200	FCFV100D1M0200M	FCFV100T1M0200M	FCFV100P1M0200M
1"	30 - 300	251	206	200	FCFV100D1M0300M	FCFV100T1M0300M	FCFV100P1M0300M
1"	60 - 600	251	206	200	FCFV100D1M0600M	FCFV100T1M0600M	FCFV100P1M0600M
1"	100 - 1000	251	206	200	FCFV100D1M1000M	FCFV100T1M1000M	FCFV100P1M1000M

FC – COMPACT VERSION FLOWMETERS

NAOH 30% SCALE – SS FLOAT

LIQUID DENSITY: 1.33 KG/L – 20°C – BSP SOCKET THREADED UNIONS

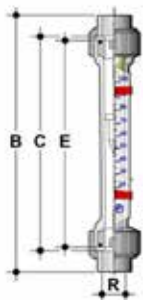

FCFV

Float: AISI 316 Stainless Steel

R	Flow rate range for NaOH 30% [l/h]	B	E	C	Transparent PVC-T code	Polysulfone code
3/8"	0,5 - 8,5	198	171	165	FCFV038T3X0085	FCFV038P3X0085
3/8"	2,5 - 40	198	171	165	FCFV038T3X0040	FCFV038P3X0040
3/8"	10 - 120	198	171	165	FCFV038T3X0120	FCFV038P3X0120
3/8"	15 - 180	198	171	165	FCFV038T3X0180	FCFV038P3X0180
1/2"	2,5 - 37,5	212	176	170	FCFV012T3X0375	FCFV012P3X0375
1/2"	4 - 75	212	176	170	FCFV012T3X0075	FCFV012P3X0075
1/2"	5 - 140	212	176	170	FCFV012T3X0140	FCFV012P3X0140
1/2"	9 - 220	212	176	170	FCFV012T3X0220	FCFV012P3X0220
1/2"	24 - 360	212	176	170	FCFV012T3X0360	FCFV012P3X0360
3/4"	6 - 135	232	191	185	FCFV034T3X0135	FCFV034P3X0135
3/4"	13 - 230	232	191	185	FCFV034T3X0230	FCFV034P3X0230
3/4"	20 - 350	232	191	185	FCFV034T3X0350	FCFV034P3X0350
3/4"	25 - 600	232	191	185	FCFV034T3X0600	FCFV034P3X0600
1"	10 - 220	251	206	200	FCFV100T3X0220	FCFV100P3X0220
1"	20 - 350	251	206	200	FCFV100T3X0350	FCFV100P3X0350
1"	25 - 650	251	206	200	FCFV100T3X0650	FCFV100P3X0650
1"	50 - 1000	251	206	200	FCFV100T3X1000	FCFV100P3X1000

Float: AISI 316 Stainless Steel + Magnet

R	Flow rate range for NaOH 30% [l/h]	B	E	C	Transparent PVC-T code	Polysulfone code
3/8"	0,5 - 8,5	198	171	165	FCFV038T3X0085M	FCFV038P3X0085M
3/8"	2,5 - 40	198	171	165	FCFV038T3X0040M	FCFV038P3X0040M
3/8"	10 - 120	198	171	165	FCFV038T3X0120M	FCFV038P3X0120M
3/8"	15 - 180	198	171	165	FCFV038T3X0180M	FCFV038P3X0180M
1/2"	2,5 - 37,5	212	176	170	FCFV012T3X0375M	FCFV012P3X0375M
1/2"	4 - 75	212	176	170	FCFV012T3X0075M	FCFV012P3X0075M
1/2"	5 - 140	212	176	170	FCFV012T3X0140M	FCFV012P3X0140M
1/2"	9 - 220	212	176	170	FCFV012T3X0220M	FCFV012P3X0220M
1/2"	24 - 360	212	176	170	FCFV012T3X0360M	FCFV012P3X0360M
3/4"	6 - 135	232	191	185	FCFV034T3X0135M	FCFV034P3X0135M
3/4"	13 - 230	232	191	185	FCFV034T3X0230M	FCFV034P3X0230M
3/4"	20 - 350	232	191	185	FCFV034T3X0350M	FCFV034P3X0350M
3/4"	25 - 600	232	191	185	FCFV034T3X0600M	FCFV034P3X0600M
1"	10 - 220	251	206	200	FCFV100T3X0220M	FCFV100P3X0220M
1"	20 - 350	251	206	200	FCFV100T3X0350M	FCFV100P3X0350M
1"	25 - 650	251	206	200	FCFV100T3X0650M	FCFV100P3X0650M
1"	50 - 1000	251	206	200	FCFV100T3X1000M	FCFV100P3X1000M

FC – COMPACT VERSION FLOWMETERS

NAOH 30% SCALE – PP FLOAT

LIQUID DENSITY: 1.33 KG/L - 20°C - BSP SOCKET THREADED UNIONS

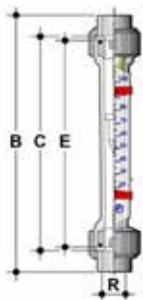

FCFV

Float: PP (Polypropylene) red

FC SERIES

R	Flow rate range for NaOH 30% [l/h]	B	E	C	Transparent PVC-T code	Polysulfone code
3/8"	0,25 - 3	198	171	165	FCFV038T3M0003	FCFV038P3M0003
3/8"	1 - 17	198	171	165	FCFV038T3M0017	FCFV038P3M0017
3/8"	2,5 - 45	198	171	165	FCFV038T3M0045	FCFV038P3M0045
3/8"	5 - 75	198	171	165	FCFV038T3M0075	FCFV038P3M0075
1/2"	1 - 12,5	212	176	170	FCFV012T3M0125	FCFV012P3M0125
1/2"	2 - 34	212	176	170	FCFV012T3M0034	FCFV012P3M0034
1/2"	2,5 - 63	212	176	170	FCFV012T3M0063	FCFV012P3M0063
1/2"	5 - 104	212	176	170	FCFV012T3M0104	FCFV012P3M0104
1/2"	10 - 170	212	176	170	FCFV012T3M0170	FCFV012P3M0170
3/4"	3,5 - 60	232	191	185	FCFV034T3M0060	FCFV034P3M0060
3/4"	5 - 92	232	191	185	FCFV034T3M0092	FCFV034P3M0092
3/4"	8 - 165	232	191	185	FCFV034T3M0165	FCFV034P3M0165
3/4"	20 - 380	232	191	185	FCFV034T3M0380	FCFV034P3M0380
1"	5 - 90	251	206	200	FCFV100T3M0090	FCFV100P3M0090
1"	7,5 - 150	251	206	200	FCFV100T3M0150	FCFV100P3M0150
1"	20 - 360	251	206	200	FCFV100T3M0360	FCFV100P3M0360
1"	25 - 650	251	206	200	FCFV100T3M0650	FCFV100P3M0650

Float: PP (Polypropylene) red + Magnet

R	Flow rate range for NaOH 30% [l/h]	B	E	C	Transparent PVC-T code	Polysulfone code
3/8"	0,25 - 3	198	171	165	FCFV038T3M0003M	FCFV038P3M0003M
3/8"	1 - 17	198	171	165	FCFV038T3M0017M	FCFV038P3M0017M
3/8"	2,5 - 45	198	171	165	FCFV038T3M0045M	FCFV038P3M0045M
3/8"	5 - 75	198	171	165	FCFV038T3M0075M	FCFV038P3M0075M
1/2"	1 - 12,5	212	176	170	FCFV012T3M0125M	FCFV012P3M0125M
1/2"	2 - 34	212	176	170	FCFV012T3M0034M	FCFV012P3M0034M
1/2"	2,5 - 63	212	176	170	FCFV012T3M0063M	FCFV012P3M0063M
1/2"	5 - 104	212	176	170	FCFV012T3M0104M	FCFV012P3M0104M
1/2"	10 - 170	212	176	170	FCFV012T3M0170M	FCFV012P3M0170M
3/4"	3,5 - 60	232	191	185	FCFV034T3M0060M	FCFV034P3M0060M
3/4"	5 - 92	232	191	185	FCFV034T3M0092M	FCFV034P3M0092M
3/4"	8 - 165	232	191	185	FCFV034T3M0165M	FCFV034P3M0165M
3/4"	20 - 380	232	191	185	FCFV034T3M0380M	FCFV034P3M0380M
1"	5 - 90	251	206	200	FCFV100T3M0090M	FCFV100P3M0090M
1"	7,5 - 150	251	206	200	FCFV100T3M0150M	FCFV100P3M0150M
1"	20 - 360	251	206	200	FCFV100T3M0360M	FCFV100P3M0360M
1"	25 - 650	251	206	200	FCFV100T3M0650M	FCFV100P3M0650M

FC – COMPACT VERSION FLOWMETERS

NAOH 50% SCALE – SS FLOAT

LIQUID DENSITY: 1.53 KG/L – 20°C – BSP SOCKET THREADED UNIONS

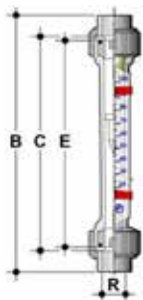

FCFV

Float: AISI 316 Stainless Steel

R	Flow rate range for NaOH 50% [l/h]	B	E	C	Transparent PVC-T code	Polysulfone code
3/8"	0.05-1.4	198	171	165	FCFV038T5X0014	FCFV038P5X0014
3/8"	0.5-8	198	171	165	FCFV038T5X0008	FCFV038P5X0008
3/8"	2.5-40	198	171	165	FCFV038T5X0040	FCFV038P5X0040
3/8"	4-55	198	171	165	FCFV038T5X0055	FCFV038P5X0055
1/2"	0.25-6.5	212	176	170	FCFV012T5X0065	FCFV012P5X0065
1/2"	1-15	212	176	170	FCFV012T5X0015	FCFV012P5X0015
1/2"	2-36	212	176	170	FCFV012T5X0036	FCFV012P5X0036
1/2"	4-75	212	176	170	FCFV012T5X0075	FCFV012P5X0075
1/2"	6-140	212	176	170	FCFV012T5X0140	FCFV012P5X0140
3/4"	2.5-30	232	191	185	FCFV034T5X0030	FCFV034P5X0030
3/4"	3-65	232	191	185	FCFV034T5X0065	FCFV034P5X0065
3/4"	3.5-135	232	191	185	FCFV034T5X0135	FCFV034P5X0135
3/4"	20-320	232	191	185	FCFV034T5X0320	FCFV034P5X0320
1"	2.5-55	251	206	200	FCFV100T5X0055	FCFV100P5X0055
1"	5-125	251	206	200	FCFV100T5X0125	FCFV100P5X0125
1"	20-300	251	206	200	FCFV100T5X0300	FCFV100P5X0300
1"	25-600	251	206	200	FCFV100T5X0600	FCFV100P5X0600

Float: AISI 316 Stainless Steel + Magnet

R	Flow rate range for NaOH 50% [l/h]	B	E	C	Transparent PVC-T code	Polysulfone code
3/8"	0.05-1.4	198	171	165	FCFV038T5X0014M	FCFV038P5X0014M
3/8"	0.5-8	198	171	165	FCFV038T5X0008M	FCFV038P5X0008M
3/8"	2.5-40	198	171	165	FCFV038T5X0040M	FCFV038P5X0040M
3/8"	4-55	198	171	165	FCFV038T5X0055M	FCFV038P5X0055M
1/2"	0.25-6.5	212	176	170	FCFV012T5X0065M	FCFV012P5X0065M
1/2"	1-15	212	176	170	FCFV012T5X0015M	FCFV012P5X0015M
1/2"	2-36	212	176	170	FCFV012T5X0036M	FCFV012P5X0036M
1/2"	4-75	212	176	170	FCFV012T5X0075M	FCFV012P5X0075M
1/2"	6-140	212	176	170	FCFV012T5X0140M	FCFV012P5X0140M
3/4"	2.5-30	232	191	185	FCFV034T5X0030M	FCFV034P5X0030M
3/4"	3-65	232	191	185	FCFV034T5X0065M	FCFV034P5X0065M
3/4"	3.5-135	232	191	185	FCFV034T5X0135M	FCFV034P5X0135M
3/4"	20-320	232	191	185	FCFV034T5X0320M	FCFV034P5X0320M
1"	2.5-55	251	206	200	FCFV100T5X0055M	FCFV100P5X0055M
1"	5-125	251	206	200	FCFV100T5X0125M	FCFV100P5X0125M
1"	20-300	251	206	200	FCFV100T5X0300M	FCFV100P5X0300M
1"	25-600	251	206	200	FCFV100T5X0600M	FCFV100P5X0600M

FC – COMPACT VERSION FLOWMETERS

NAOH 50% SCALE – PP FLOAT

LIQUID DENSITY: 1.53 KG/L - 20°C - BSP SOCKET THREADED UNIONS

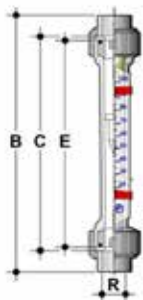

FCFV

Float: PP (Polypropylene) red

FC SERIES

R	Flow rate range for NaOH 50% [l/h]	B	E	C	Transparent PVC-T code	Polysulfone code
3/8"	0,025 - 0,5	198	171	165	FCFV038T5M0005	FCFV038P5M0005
3/8"	0,25 - 2,75	198	171	165	FCFV038T5M0275	FCFV038P5M0275
3/8"	0,5 - 9	198	171	165	FCFV038T5M0009	FCFV038P5M0009
3/8"	1 - 21	198	171	165	FCFV038T5M0021	FCFV038P5M0021
1/2"	0,1 - 2	212	176	170	FCFV012T5M0002	FCFV012P5M0002
1/2"	0,25 - 5,5	212	176	170	FCFV012T5M0055	FCFV012P5M0055
1/2"	0,5 - 12,5	212	176	170	FCFV012T5M0125	FCFV012P5M0125
1/2"	2 - 25,5	212	176	170	FCFV012T5M0255	FCFV012P5M0255
1/2"	2,5 - 47,5	212	176	170	FCFV012T5M0475	FCFV012P5M0475
3/4"	1 - 10	232	191	185	FCFV034T5M0010	FCFV034P5M0010
3/4"	1 - 19	232	191	185	FCFV034T5M0019	FCFV034P5M0019
3/4"	2 - 45	232	191	185	FCFV034T5M0045	FCFV034P5M0045
3/4"	4 - 130	232	191	185	FCFV034T5M0130	FCFV034P5M0130
1"	1 - 15	251	206	200	FCFV100T5M0015	FCFV100P5M0015
1"	2 - 40	251	206	200	FCFV100T5M0040	FCFV100P5M0040
1"	5 - 110	251	206	200	FCFV100T5M0110	FCFV100P5M0110
1"	10 - 260	251	206	200	FCFV100T5M0260	FCFV100P5M0260

Float: PP (Polypropylene) red + Magnet

R	Flow rate range for NaOH 50% [l/h]	B	E	C	Transparent PVC-T code	Polysulfone code
3/8"	0,025 - 0,5	198	171	165	FCFV038T5M0005M	FCFV038P5M0005M
3/8"	0,25 - 2,75	198	171	165	FCFV038T5M0275M	FCFV038P5M0275M
3/8"	0,5 - 9	198	171	165	FCFV038T5M0009M	FCFV038P5M0009M
3/8"	1 - 21	198	171	165	FCFV038T5M0021M	FCFV038P5M0021M
1/2"	0,1 - 2	212	176	170	FCFV012T5M0002M	FCFV012P5M0002M
1/2"	0,25 - 5,5	212	176	170	FCFV012T5M0055M	FCFV012P5M0055M
1/2"	0,5 - 12,5	212	176	170	FCFV012T5M0125M	FCFV012P5M0125M
1/2"	2 - 25,5	212	176	170	FCFV012T5M0255M	FCFV012P5M0255M
1/2"	2,5 - 47,5	212	176	170	FCFV012T5M0475M	FCFV012P5M0475M
3/4"	1 - 10	232	191	185	FCFV034T5M0010M	FCFV034P5M0010M
3/4"	1 - 19	232	191	185	FCFV034T5M0019M	FCFV034P5M0019M
3/4"	2 - 45	232	191	185	FCFV034T5M0045M	FCFV034P5M0045M
3/4"	4 - 130	232	191	185	FCFV034T5M0130M	FCFV034P5M0130M
1"	1 - 15	251	206	200	FCFV100T5M0015M	FCFV100P5M0015M
1"	2 - 40	251	206	200	FCFV100T5M0040M	FCFV100P5M0040M
1"	5 - 110	251	206	200	FCFV100T5M0110M	FCFV100P5M0110M
1"	10 - 260	251	206	200	FCFV100T5M0260M	FCFV100P5M0260M

FC – COMPACT VERSION FLOWMETERS

HCL 30-33% SCALE – PP FLOAT

LIQUID DENSITY: 1.16 KG/L - 20°C - BSP SOCKET THREADED UNIONS

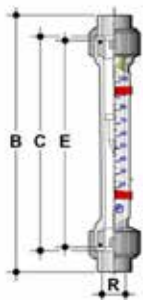

FCFV

Float: PP (Polypropylene) red

R	Flow rate range for HCl 30 - 33% [l/h]	B	E	C	Transparent PVC-T code	Polysulfone code
3/8"	1,4 - 14	198	171	165	FCFV038T2M0014	FCFV038P2M0014
3/8"	2 - 18	198	171	165	FCFV038T2M0018	FCFV038P2M0018
3/8"	5 - 45	198	171	165	FCFV038T2M0045	FCFV038P2M0045
3/8"	10 - 90	198	171	165	FCFV038T2M0090	FCFV038P2M0090
3/8"	14 - 140	198	171	165	FCFV038T2M0140	FCFV038P2M0140
1/2"	2 - 23	212	176	170	FCFV012T2M0023	FCFV012P2M0023
1/2"	5 - 45	212	176	170	FCFV012T2M0045	FCFV012P2M0045
1/2"	10 - 90	212	176	170	FCFV012T2M0090	FCFV012P2M0090
1/2"	14 - 140	212	176	170	FCFV012T2M0140	FCFV012P2M0140
1/2"	19 - 185	212	176	170	FCFV012T2M0185	FCFV012P2M0185
1/2"	30 - 300	212	176	170	FCFV012T2M0300	FCFV012P2M0300
3/4"	7,5 - 75	232	191	185	FCFV034T2M0075	FCFV034P2M0075
3/4"	14 - 140	232	191	185	FCFV034T2M0140	FCFV034P2M0140
3/4"	19 - 185	232	191	185	FCFV034T2M0185	FCFV034P2M0185
3/4"	30 - 325	232	191	185	FCFV034T2M0325	FCFV034P2M0325
3/4"	45 - 600	232	191	185	FCFV034T2M0600	FCFV034P2M0600
1"	19 - 185	251	206	200	FCFV100T2M0185	FCFV100P2M0185
1"	28 - 280	251	206	200	FCFV100T2M0280	FCFV100P2M0280
1"	55 - 550	251	206	200	FCFV100T2M0550	FCFV100P2M0550
1"	90 - 900	251	206	200	FCFV100T2M0900	FCFV100P2M0900

Float: PP (Polypropylene) red + Magnet

R	Flow rate range for HCl 30 - 33% [l/h]	B	E	C	Transparent PVC-T code	Polysulfone code
3/8"	1,4 - 14	198	171	165	FCFV038T2M0014M	FCFV038P2M0014M
3/8"	2 - 18	198	171	165	FCFV038T2M0018M	FCFV038P2M0018M
3/8"	5 - 45	198	171	165	FCFV038T2M0045M	FCFV038P2M0045M
3/8"	10 - 90	198	171	165	FCFV038T2M0090M	FCFV038P2M0090M
3/8"	14 - 140	198	171	165	FCFV038T2M0140M	FCFV038P2M0140M
1/2"	2 - 23	212	176	170	FCFV012T2M0023M	FCFV012P2M0023M
1/2"	5 - 45	212	176	170	FCFV012T2M0045M	FCFV012P2M0045M
1/2"	10 - 90	212	176	170	FCFV012T2M0090M	FCFV012P2M0090M
1/2"	14 - 140	212	176	170	FCFV012T2M0140M	FCFV012P2M0140M
1/2"	19 - 185	212	176	170	FCFV012T2M0185M	FCFV012P2M0185M
1/2"	30 - 300	212	176	170	FCFV012T2M0300M	FCFV012P2M0300M
3/4"	7,5 - 75	232	191	185	FCFV034T2M0075M	FCFV034P2M0075M
3/4"	14 - 140	232	191	185	FCFV034T2M0140M	FCFV034P2M0140M
3/4"	19 - 185	232	191	185	FCFV034T2M0185M	FCFV034P2M0185M
3/4"	30 - 325	232	191	185	FCFV034T2M0325M	FCFV034P2M0325M
3/4"	45 - 600	232	191	185	FCFV034T2M0600M	FCFV034P2M0600M
1"	19 - 185	251	206	200	FCFV100T2M0185M	FCFV100P2M0185M
1"	28 - 280	251	206	200	FCFV100T2M0280M	FCFV100P2M0280M
1"	55 - 550	251	206	200	FCFV100T2M0550M	FCFV100P2M0550M
1"	90 - 900	251	206	200	FCFV100T2M0900M	FCFV100P2M0900M

FC – COMPACT VERSION FLOWMETERS

AIR SCALE – PP FLOAT

ABSOLUTE PRESSURE: 1.013 BAR AT 20°C – BSP SOCKET THREADED UNIONS

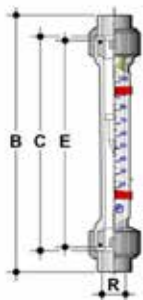

FCFV

Float: PP (Polypropylene) red

FC SERIES

R	Flow rate range for air Nm ³ /h	B	E	C	Trogamid code
3/8"	0,025 - 0,25	198	171	165	FCFV038D0M00025
3/8"	0,04 - 0,4	198	171	165	FCFV038D0M00004
3/8"	0,1 - 1	198	171	165	FCFV038D0M00001
3/8"	0,2 - 2	198	171	165	FCFV038D0M00002
1/2"	0,045 - 0,45	212	176	170	FCFV012D0M00045
1/2"	0,09 - 0,9	212	176	170	FCFV012D0M00009
1/2"	0,15 - 1,5	212	176	170	FCFV012D0M00015
1/2"	0,25 - 2,5	212	176	170	FCFV012D0M00025
1/2"	0,38 - 3,8	212	176	170	FCFV012D0M00038
1/2"	0,4 - 4,8	212	176	170	FCFV012D0M00048
3/4"	0,12 - 1,2	232	191	185	FCFV034D0M00012
3/4"	0,3 - 2,5	232	191	185	FCFV034D0M00025
3/4"	0,45 - 4,5	232	191	185	FCFV034D0M00045
3/4"	0,6 - 6,5	232	191	185	FCFV034D0M00065
3/4"	1 - 10	232	191	185	FCFV034D0M00010
1"	0,6 - 4	251	206	200	FCFV100D0M00004
1"	0,7 - 7	251	206	200	FCFV100D0M00007
1"	1,1 - 11	251	206	200	FCFV100D0M00011
1"	2 - 14	251	206	200	FCFV100D0M00014

Float: PP (Polypropylene) red + Magnet

R	Flow rate range for air Nm ³ /h	B	E	C	Trogamid code
1/2"	0,12 - 1,2	212	176	170	FCFV012D0M00012M
1/2"	0,2 - 2	212	176	170	FCFV012D0M00002M
1/2"	0,35 - 3,5	212	176	170	FCFV012D0M00035M
1/2"	0,6 - 6	212	176	170	FCFV012D0M00006M
1/2"	1,0 - 10	212	176	170	FCFV012D0M00010M
1/2"	1,25 - 12,5	212	176	170	FCFV012D0M00125M
3/4"	0,3 - 3	232	191	185	FCFV034D0M00003M
3/4"	0,6 - 6	232	191	185	FCFV034D0M00006M
3/4"	1,2 - 12	232	191	185	FCFV034D0M00012M
3/4"	1,6 - 16	232	191	185	FCFV034D0M00016M
3/4"	2 - 24	232	191	185	FCFV034D0M00024M
1"	1 - 10	251	206	200	FCFV100D0M00010M
1"	1,7 - 17	251	206	200	FCFV100D0M00017M
1"	2,7 - 27	251	206	200	FCFV100D0M00027M
1"	3,5 - 35	251	206	200	FCFV100D0M00035M

FS-FC



Accessories for Variable
Area Flowmeters



VARIABLE AREA FLOWMETER ACCESSORIES

FS-FC SERIES

SS AISI 316 Connections

SS AISI 316 Connections, each Kit composed by 2 union ends and 2 nuts.

d	Code
3/8"	KFX038
1/2"	KFX012
3/4"	KFX034
1"	KFX100
1"1/4	KFX114
1"1/2	KFX112
2"	KFX200
2"1/2	KFX212

Malleable Iron Connections

Malleable Iron Connections, each Kit composed by 2 union ends and 2 nuts

d	Code
3/8"	KFC038
1/2"	KFC012
3/4"	KFC034
1"	KFC100
1"1/4	KFC114
1"1/2	KFC112
2"	KFC200
2"1/2	KFC212

VARIABLE AREA FLOWMETER ACCESSORIES

FS-FC SERIES



Q/BLV

Union end for solvent welding BS series*

d	To be used with:	Code
1/2"	CM - FS - FC - DK - DKL - DKD	QBLV012
3/4"	FS - FC - DK - DKL - DKD	QBLV034
1"	FS - FC - DK - DKL - DKD	QBLV100
1 1/4"	FS - FC - DK - DKL - DKD	QBLV114
1 1/2"	FS - FC - DK - DKL - DKD	QBLV112
2"	FS - FC - DK - DKL - DKD	QBLV200
2 1/2"	FS	QBLV075

*One piece



Q/BAV

Union end for solvent welding ASTM series*

d	To be used with:	Code
1/2"	CM - FS - FC - DK - DKL - DKD	QBAV012
3/4"	FS - FC - DK - DKL - DKD	QBAV034
1"	FS - FC - DK - DKL - DKD	QBAV100
1 1/4"	FS - FC - DK - DKL - DKD	QBAV114
1 1/2"	FS - FC - DK - DKL - DKD	QBAV112
2"	FS - FC - DK - DKL - DKD	QBAV200

*One piece

VARIABLE AREA FLOWMETER

ACCESSORIES

FS-FC SERIES



Q/BNV

Union end NPT threaded socket*

R	To be used with:	Code
1/2"	CM - FS - FC - DK - DKL - DKD	QBNV012
3/4"	FS - FC - DK - DKL - DKD	QBNV034
1"	FS - FC - DK - DKL - DKD	QBNV100
1 1/4"	FS - FC - DK - DKL - DKD	QBNV114
1 1/2"	FS - FC - DK - DKL - DKD	QBNV112
2"	FS - FC - DK - DKL - DKD	QBNV200

*One piece



Q/BJV

Union end for solvent welding JIS series*

d	To be used with:	Code
1/2"	CM - FS - FC - DK - DKL - DKD	QBJV012
3/4"	FS - FC - DK - DKL - DKD	QBJV034
1"	FS - FC - DK - DKL - DKD	QBJV100
1 1/4"	FS - FC - DK - DKL - DKD	QBJV114
1 1/2"	FS - FC - DK - DKL - DKD	QBJV112
2"	FS - FC - DK - DKL - DKD	QBJV200

*One piece

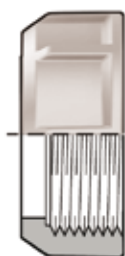

EFGM

PP-GR Union nut with BS parallel threads for BIGM, BIFGM, BIFOM, BIROM, BIFXM, BIRXM unions and for variable area flowmeter FS - FC*

R	d BIGM	PN	Code
1"	20	10	EFGM100
1 1/4"	25	10	EFGM114
1 1/2"	32	10	EFGM112
2"	40	10	EFGM200
2 1/4"	50	10	EFGM214
2 3/4"	63	10	EFGM234

*One piece

VARIABLE AREA FLOWMETER ACCESSORIES

FS-FC SERIES



Q/BIGM

PP-H Union end for socket welding*

d	To be used with:	Code
20	CM-DK-DKL	QBIGM020
25	DK-DKL	QBIGM025
32	DK-DKL	QBIGM032
40	DK-DKL	QBIGM040
50	DK-DKL	QBIGM050
63	DK-DKL	QBIGM063

*One piece

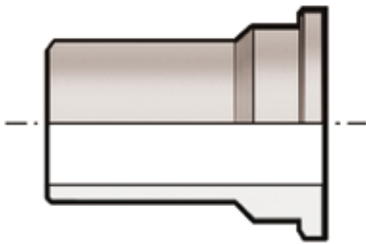

Q/BBM-L

End connector SDR11 in PP-H SDR11 long spigot for butt welding

d	DN	Code
20	15	QBBML1020
25	20	QBBML1025
32	25	QBBML1032
40	32	QBBML1040
50	40	QBBML1050
63	50	QBBML1063
75	65	QBBML1075

*One piece

VARIABLE AREA FLOWMETER

ACCESSORIES

FS-FC SERIES

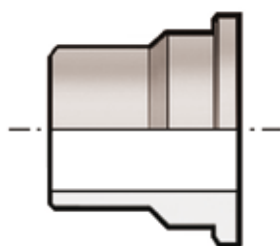

Q/BBM-C

Union End short spigot for butt welding*

d	DN	Code
20	15	QBBMC11020
25	20	QBBMC11025
32	25	QBBMC11032
40	32	QBBMC11040
50	40	QBBMC11050
63	50	QBBMC11063
75	65	QBBMC11075

*One piece



EFGF

PVDF Union nut with BS parallel threads for BIGF, BIFXF and BIRXF unions and for variable area flowmeter FS - FC*

R	d BIGF	Code
1"	20	EFGF100
1 1/4"	25	EFGF114
1 1/2"	32	EFGF112
2"	40	EFGF200
2 1/4"	52	EFGF214
2 3/4"	63	EFGF234

*One piece



Q/BIGF

PVDF Union end for socket welding*

d	PN	Code
20	16	QBIGF020
25	16	QBIGF025
32	16	QBIGF032
40	16	QBIGF040
50	16	QBIGF050
63	16	QBIGF063

*One piece

VARIABLE AREA FLOWMETER ACCESSORIES

FS-FC SERIES



EFC

PVC-C Union nut with BS parallel threads for BIC, BIFC, BIFOC, BIROC, BIFXC, BIRXC unions and for variable area flowmeter FS - FC.*

R1	d BIC	PN	Code
3/4"	16	16	EFC034
1"	20	16	EFC100
1" 1/4	25	16	EFC114
1" 1/2	32	16	EFC112
2"	40	16	EFC200
2" 1/4	50	16	EFC214
2" 3/4	63	16	EFC234

*One piece



Q/BIC

Union end for solvent welding metric series*

d	To be used with:	Code
20	CM - FS - FC - DK - DKL - DKD	QBIC020
25	FS - FC - DK - DKL - DKD	QBIC025
32	FS - FC - DK - DKL - DKD	QBIC032
40	FS - FC - DK - DKL - DKD	QBIC040
50	FS - FC - DK - DKL - DKD	QBIC050
63	FS - FC - DK - DKL - DKD	QBIC063

*One piece



Q/BFC

Union end BS parallel threaded socket*

R	To be used with:	Code
1/2"	CM - FS - FC - DK - DKL - DKD	QBFC012
3/4"	FS - FC - DK - DKL - DKD	QBFC034
1"	FS - FC - DK - DKL - DKD	QBFC100
1"1/4	FS - FC - DK - DKL - DKD	QBFC114
1"1/2	FS - FC - DK - DKL - DKD	QBFC112
2"	FS - FC - DK - DKL - DKD	QBFC200

*One piece

VARIABLE AREA FLOWMETER

ACCESSORIES

FS-FC SERIES



Q/BAC

Union end for solvent welding ASTM series*

d	To be used with:	Code
1/2"	CM - VM - FS - FC - BIC	QBAC012
3/4"	FS - FC - DK - DKL - DKD	QBAC034
1"	FS - FC - DK - DKL - DKD	QBAC100
1 1/4"	FS - FC - DK - DKL - DKD	QBAC114
1 1/2"	FS - FC - DK - DKL - DKD	QBAC112
2"	FS - FC - DK - DKL - DKD	QBAC200

*One piece



Q/BNC

Union end NPT threaded socket*

R	To be used with:	Code
1/2"	CM - FS - FC - DK - DKL - DKD	QBNC012
3/4"	FS - FC - DK - DKL - DKD	QBNC034
1"	FS - FC - DK - DKL - DKD	QBNC100
1 1/4"	FS - FC - DK - DKL - DKD	QBNC114
1 1/2"	FS - FC - DK - DKL - DKD	QBNC112
2"	FS - FC - DK - DKL - DKD	QBNC200

*One piece

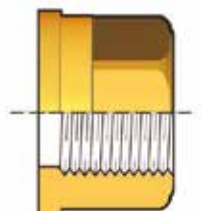

Q/BFO

Brass Union end: BS parallel threaded socket*

R	Code
3/8"	QBFO038
1/2"	QBFO012
3/4"	QBFO034
1"	QBFO100
1 1/4"	QBFO114
1 1/2"	QBFO112
2"	QBFO200

*One piece

VARIABLE AREA FLOWMETER ACCESSORIES

FS-FC SERIES

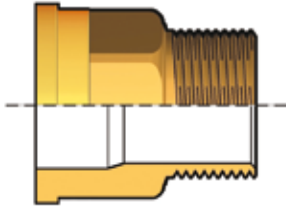

Q/BRO

Brass Union end: BS parallel male threaded*

R	Code
3/8"	QBRO038
1/2"	QBRO012
3/4"	QBRO034
1"	QBRO100
1 1/4"	QBRO114
1 1/2"	QBRO112
2"	QBRO200

*One piece

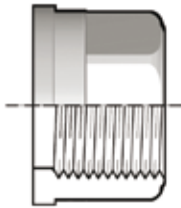

Q/BFX

Stainless Steel A316L Union end: BS parallel threaded socket*

R	Code
3/8"	QBFX038
1/2"	QBFX012
3/4"	QBFX034
1"	QBFX100
1 1/4"	QBFX114
1 1/2"	QBFX112
2"	QBFX200

*One piece

VARIABLE AREA FLOWMETER

ACCESSORIES

FS-FC SERIES

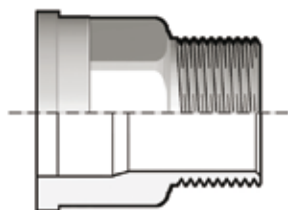

Q/BRX

Stainless Steel A316L Union end: BS parallel male threaded*

R	Code
3/8"	QBRX038
1/2"	QBRX012
3/4"	QBRX034
1"	QBRX100
1"1/4	QBRX114
1"1/2	QBRX112
2"	QBRX200

*One piece

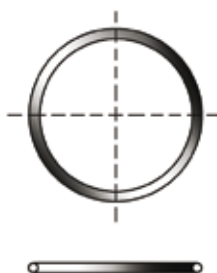

O-Ring

FKM O-Ring. 2 O-Rings have to be ordered for each flowmeter

d	R	Code
16	3/8"	OR3062F
20	1/2"	OR4081F
25	3/4"	OR4112F
32	1"	OR4131F
40	1"1/4	OR0150F
50	1"1/2	OR4200F
63	2"	OR4275F
75	2"1/2	OR6325F

VARIABLE AREA FLOWMETER ACCESSORIES

FS-FC SERIES



MICROSWITCH

FS-FC Microswitch

OPERATING MODE:

The bistable limit switch type are clamped on the external guide of the flowmeter tube.

The passage of the magnetic floater activates the contact.

TECHNICAL FEATURES:

- Bistable operating mode
- High resistance to vibrations
- Total absence of feedback effects
- Total absence of interferences in relation to a supplementary limit switch
- Inertia reduced to a minimum
- Electrical protection: IP 65
- Easy connection
- Special version provided with TRIAC is available.

Technical Data	
Contact Material	Rhodium with inert protective gas
Max operating power	10 Watt, 12 VA
Max operating voltage	250 V AC/DC
Contact resistance	0.1 Ω
Contact insulation resistance	1011 Ω
Closing time	2 ms
Opening time	0.07 ms
Temperature	- 40 to + 80°C
Body material	technopolymer
Connection	DIN 43650
Protection	IP 65
Max input peak	0.5 A
Max current	22 mA @ 220 V = 45 mA @ 110 V = 0.2 A @ 24 V = 0.5 A @ 10 V ≈

CAUTION: The overshooting of the above values may cause contacts sticks

Description	A	B	C	Code
*Microswitch MIN for version FC d16 (3/8"), d20 (1/2") e d25 (3/4")	34	37	17	MSMIN02
*Microswitch MAX for version FC d16 (3/8"), d20 (1/2") e d25 (3/4")	34	37	17	MSMAX02
*Microswitch MIN for FS and FC d32 (1")	45	36	25	MSMIN01
*Microswitch MAX for FS and FC d32 (1")	45	36	25	MSMAX01

* To be used with floats + magnet integrated

FS-FC



Spare parts for
Variable Area Flowmeters



VARIABLE AREA FLOWMETERS

SPARE PARTS

FS-FC SERIES

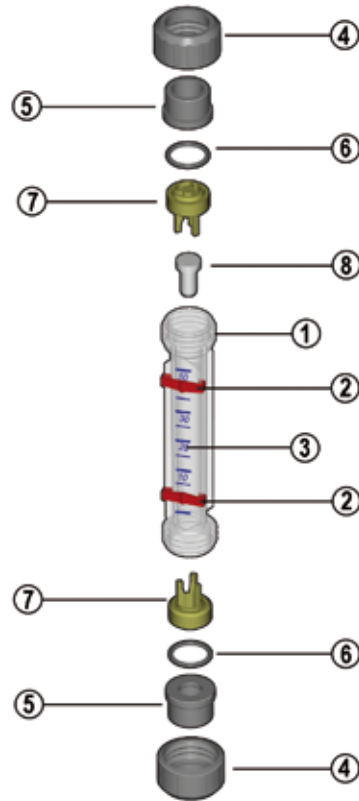

Float

Standard float and magnetic float

d	DN	Position	Stainless Steel for liquids Code	SS + magnet for liquids Code	PP for liquids Code	PP + magnet for liquids Code
16	10	8	FL016X	FL016XM	FL016M	FL016MM
20	15	8	FL020X	FL020XM	FL020M	FL020MM
25	20	8	FL025X	FL025XM	FL025M	FL025MM
32	25	8	FL032X	FL032XM	FL032M	FL032MM
40	32	8	FL040X	FL040XM	FL040M	FL040MM
50	40	8	FL050X	FL050XM	FL050M	FL050MM
63	50	8	FL063X	FL063XM	FL063M	FL063MM
75	65	8	FL075X	FL075XM	FL075M	FL075MM
75 body 68	65	8	FL07568X	FL07568XM	FL07568M	FL07568MM

d	DN	Position	PP for gases Code	PP + magnets for gases Code
16	10	8	FL016GM	FL016GMM
20	15	8	FL020GM	FL020GMM
25	20	8	FL025GM	FL025GMM
32	25	8	FL032GM	FL032GMM
40	32	8	FL040GM	FL040GMM
50	40	8	FL050GM	FL050GMM
63	50	8	FL063GM	FL063GMM
75	65	8	FL075GM	FL075GMM

VARIABLE AREA FLOWMETERS

SPARE PARTS

FS-FC SERIES

Float stop

FS-FC float stop

d	DN	Position	FS series Code	FC series Code
16	10	7	-	STFC016P
20	15	7	-	STFC020P
25	20	7	STFS025P	STFC025P
32	25	7	STFS032P	STFC032P
40	32	7	STFS040P	-
50	40	7	STFS050P	-
63	50	7	STFS063P	-
75	65	7	lower STFS075PINF	-
75	65	7	upper STFS075PSUP	-

Note: two pieces needed for FS range and one for FC range

O-Ring

EPDM O-Ring. 2 O-Rings have to be ordered for each flowmeter

d	R	Position	Code
16	3/8"	6	OR3062E
20	1/2"	6	OR4081E
25	3/4"	6	OR4112E
32	1"	6	OR4131E
40	1 1/4"	6	OR0150E
50	1 1/2"	6	OR4200E
63	2"	6	OR4275E
75	2 1/2"	6	OR6325E

Visual flow indicator

Visual flow indicator (two pieces)

Description	Position	Code
Visual flow indicator for FS and FC d32 (1")	2	VFI01
Visual flow indicator for FC d16 (3/8"), d20 (1/2") and d25 (3/4")	2	VFI02



EFV

Nut with parallel threads for BIV, BIFV, BFV, BLV, BIRV, BIFOV, BIROV, BIFXV, BIRXV unions and for variable area flowmeter FS - FC*

R1	PN	Code
3/4"	16	EFV034
1"	16	EFV100
1 1/4"	16	EFV114
1 1/2"	16	EFV112
2"	16	EFV200
2 1/4"	16	EFV214
2 3/4"	16	EFV234
3 1/2"	10	EFV312

*One piece

SPARE PARTS

VARIABLE AREA FLOWMETERS

SPARE PARTS

FS-FC SERIES



Q/BIV

Union end for solvent welding metric series*

d	To be used with:	Code
20	CM - FS - FC - DK - DKL -- DKD	QBIV020
25	FS - FC - DK - DKL - DKD	QBIV025
32	FS - FC - DK - DKL - DKD	QBIV032
40	FS - FC - DK - DKL - DKD	QBIV040
50	FS - FC - DK - DKL - DKD	QBIV050
63	FS - FC - DK - DKL -- DKD	QBIV063
75	FS	QBIV075

*One piece



Q/BFV

Union end BS parallel threaded socket*

R	To be used with:	Code
3/8"	CM - FS - FC - DK - DKL - DKD- S12	QBFV038
1/2"	CM - FS - FC - DK - DKL - DKD	QBFV012
3/4"	FS - FC - DK - DKL -- DKD	QBFV034
1"	FS - FC - DK - DKL - DKD	QBFV100
1 1/4"	FS - FC - DK - DKL - DKD	QBFV114
1 1/2"	FS - FC - DK - DKL - DKD	QBFV112
2"	FS - FC - DK - DKL - DKD	QBFV200
2 1/2"	FS	1RBF275000L

*One piece

Key Abbreviations

C	O-Ring code
d	Nominal external diameter in mm
DN	Nominal internal diameter in mm
EPDM	Ethylene propylene elastomer
FKM (FPM)	Fluoroelastomer
g	Weight in grams
HIPVC	PVC high impact
K	Bonnet key
Kg	Weight in kilograms
L	Length in metres
M	Bolts 61
MRS	Minimum guaranteed breaking strength of the material at 20° C - water - for 50 years of service
n	Number of flange holes
NBR	Acrylonitrile butadiene elastomer
PA-GR	Fibreglass reinforced polyamide
PBT	Polybutylene terephthalate
PE	Polyethylene
PN	Nominal pressure in bar (max. operating pressure at 20 °C water)
POM	Polyoxymethylene
PP-GR	Fibreglass reinforced polypropylene
PP-H	Polypropylene homopolymer
PVC-C	Chlorinated polyvinyl chloride
PVC-U	Unplasticized polyvinylchloride
PVDF	Polyvinylidene difluoride
PTFE	Polyethrafluorethylene
R	Nominal thread size in inches
S	Thickness series = $\frac{SDR-1}{2}$
s	Pipe thickness in mm
SDR	Standard dimension ratio = d / s
Sp	Flange thickness on flanged valves
U	Number of flange holes for flanged valves

Conditions of Supply

- **INTRODUCTORY STATEMENT:** our supplies include the products specified in our Sales confirmation and are governed by the following Terms and Conditions which the Customer declares to understand and to accept, except for possible derogations stated in an explicitly written agreement. In particular all foreign supplies will be governed by INCOTERMS, as defined by the International Chamber of Commerce.
- **PRODUCTS:** to prevent regrettable misunderstandings, **it is advisable to refer to the nomenclature and codes of our catalogues and/or price lists** for the identification of our products. The items featuring an asterisk (*), though currently on hand, are not included in our wide range of products for which stock rebuild is scheduled. Therefore our order acceptance depends upon the actual availability of the product.
- **PACKAGING:** to speed-up delivery and to facilitate warehousing at the Customer's, we reserve the right to convert the ordered quantities into multiples of the standard packages, as shown in our price list next to each item.
- **MINIMUM PURCHASE:** for orders involving a net amount of less than € 516,46 we will charge € 31 as partial recovery of the handling costs.
- **PRICES:** prices will be those in force at the time when the order was placed, except in case of forward delivery. In the latter case, the prices in force at the time of shipment will be invoiced. Our prices include normal packing; special packing, if required by the customer will be charged at cost price.
- **DELIVERY:** delivery is intended ex our Warehouse or Stores and is normally prompt, subject to being unsold. The anticipated delivery terms for unavailable items will be indicated, but these will be in no way binding or firm. If these delivery schedules cannot be kept for any reason whatsoever, the Purchaser can cancel the order only if the delay exceeds three months from the anticipated delivery date stated in our Order Confirmation. After this time lapse, we too shall be entitled to cancel any orders for items which delayed deliveries due to serious production problems.
- **SHIPMENT:** if the mode of shipment is not specifically indicated by the Customer, shipment will be effected as deemed most suitable by us. Even if the goods are sold free to destination, their transport will be at the Customer's risk. Insurance coverage will only be effected if specifically requested by the Customer.
- **PAYMENT:** the Customer cannot, for any reason whatsoever, defer payments beyond the established dates. Furthermore, we shall be fully entitled to charge interests in arrears on any and all delayed payments. These interests will be based upon the discount rate in force at that time in Italy, plus 3 unit % .
 - Unless otherwise specified, payments shall be made by opening of an irrevocable credit at call (for Foreign Countries).
 - Unless otherwise specified, payment shall be telegraphic transfer not later than 30 days after the date of invoicing (for Italy)
- **OWNERSHIP CLAUSE:** the products supplied by us will remain our property until fully paid for.
- **GUARANTEE CLAUSE:** we guarantee the good quality of our products in compliance with the standards publicized in our catalogues. However, our guarantee is limited to the repair and/or replacement of our materials, excluding any other liability, in particular for damages caused in any way whatsoever by utilization of our products. This guarantee terminates and will be no longer valid:
 - one year after the delivery of the material in question;
 - if the material is used in other way than the operating conditions specified by us;
 - if the materials are modified by people not belonging to our Company. On this subject, it should be noted that the Purchaser will incur all liabilities provided by Law for any modification of our products.We shall be duly informed about any accidents in which our products are involved and such accidents shall be reported to us immediately and within 24 Hours of their occurrence.
- **CLAIMS:** only complaints/claims reaching us by registered letter within 30 days after invoicing date will be taken into consideration. In particular, we will not accept any materials returned to us, unless their reshipment - free at our warehouses - has been duly authorized by our appropriate executive.
- **DISPUTES:** any disputes which cannot be amicably settled or settled by a court of arbitration, shall be handled by the Court of Genoa which will have jurisdiction.
- **CUSTOMER SERVICE:** our Technical and Commercial Services are available to all our Customers to provide any information on the characteristics and application sectors of our products.

The above General Terms and Conditions may be changed without previous notice.

All information contained in this collection are given in good faith and are correct at date of publication thereof.

The drawings and photographs contained in this price list are provided for illustrative purposes.

FIP Formatura Iniezione Polimeri

Loc. Pian di Parata, 16015 Casella Genova Italy

Tel. +39 0109621.1 - Fax +39 010 9621.209

info.fip@alixis.com

www.fipnet.com

UNI EN
ISO 9001
QUALITÀ

UNI EN
ISO 14001
GESTIONE
AMBIENTALE

